

# HIGH PERFORMANCE URETHANE



SUSPENSION • CHASSIS  
BUSHINGS • MOUNTS



CATALOG  
2019 1/2

FOR ALL CARS AND TRUCKS



## About Our Company

Dee Engineering has been a well-respected marketer in the automotive aftermarket since the early 1970's. In 1991 the PROTHANE division of Dee Engineering was launched with less than 100 products. Since then we have designed and produced over 5,000 kits, and parts with urethane components. We are proud to say that our reputation for quality and service is second to none and we are internationally recognized as a leader in urethane product development for domestic and import vehicles.



**PROTHANE Headquarters**  
Costa Mesa, California



**PROTHANE Manufacturing Facility**  
Ontario California



## About Our Products

We manufacture a wide range of urethane products as replacements and upgrades for OEM (factory) *rubber* bushings, mounts and parts. Urethane/Polyurethane is a term used to describe a family of elastomers (any compound exhibiting the characteristics of natural rubber, stretchy and elastic). Poly meaning "many" and "urethane" denotes the classification of the chemical structure. Polyurethane or Urethane for short, is used as a solid cast material (bushings, mounts, mount inserts, etc.) that can be compounded as soft as a rubber band or as hard as a bowling ball! Each of our products are specially formed to exact specifications for resilience, performance and durability for the specific application.



Proprietary Processes



Machine Finishing

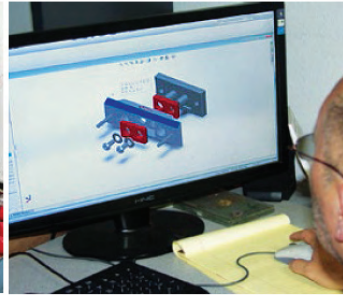

CAD/CAM Design



Computerized Welding

## Why Urethane?

Production automotive vehicles are built using rubber bushings in control arms, strut arms, leaf springs, body mounts, motor mounts, transmission mounts, sway bars and shocks. Additionally, rubber components can be found as coil spring pads, leaf spring pads and suspension bump stops. While OEM rubber components offer a soft side, for typical driving conditions, they tend to deteriorate rapidly from exposure to the elements. This contributes to premature component failure, resulting in a "spongy" ride and loss of performance handling. PROTHANE performance urethane solves that! Additionally, urethane is impervious to gas and oil, will not rot and is stronger than rubber.



## Improved Handling and Performance

Due to the firmness of our specially formulated urethane, vehicle owners that have upgraded to PROTHANE™ Total Kits and Components have experienced better handling, cornering and a firmer suspension feel. PROTHANE urethane is a "must" upgrade for High Performance vehicles where improved performance and durability are desired.



## Installation Made Easy

PROTHANE products are made to exact specifications and are direct replacements for original rubber bushings and components. No special tools are required, standard tools and equipment replace factory units.



Download complete and detailed instructions from our website for proper installation.

## Metal Shells

PROTHANE™ has a complete shell program for most popular applications. Many of our control arm bushing kits comes complete with new shells. However, in some applications, the original metal shells will need to be reused.

## Urethane Colors

PROTHANE Products are cast in RED and BLACK urethane. The Hardness/Durometer are identical for both colors is the same and there is no difference in performance. Color is a matter of preference. All part numbers are RED urethane products. Part numbers followed by BL indicate black urethane.



4-2010



#7-2002-BL '68-'74 Nova Total Kit



## Special Lubrication

PROTHANE Super Grease™ eliminates squeaking that may occur if not applied. Super Grease™ contains versatile waterproof, non-melting Teflon® specially formulated for urethane to seal out water and lubricate under the most adverse conditions. It provides superior adhering and extreme pressure qualities for optimum no-squeak performance. All kits come complete with instructions and an ample supply of PROTHANE Super Grease™

#19-1750 3 Tube Kit  
#19-1751 14oz. Tube



## Some of Our Innovations

The Engineering Department at PROTHANE is at the cutting edge of product development, employing state-of-the-art design and production techniques. Are some of the exclusive kits and components.

### "Bullet" Motor Mount Designs

"Bullet" Mustang motor mounts are the answer to solving the stock motor mount failures. Features our revolutionary poly compound between stylish fully machined billet aluminum brackets. Current models available for Mustang, Challenger, Charger and 300c



### Gen 5 Camaro Motor Mount Kit

Our exclusive "Bullet Design" mounts are fully machined billet aluminum mounts, coupled with a special urethane to provide the ultimate performance.



### Trans Mount Custom Crossmember

Custom crossmember, transmission mount kit for the '99-'04 Mustangs. Unique design in our X member provides adjustability to compensate for the varying factory tolerances. HD poly locked trans. mounts incorporates our "run safe" interlock device.

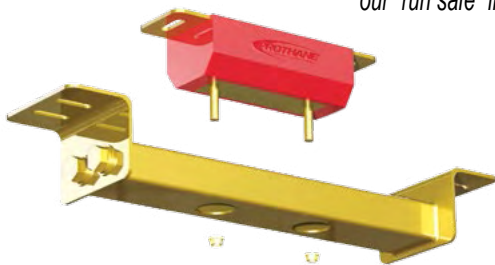

### LS-1 Motor Mount Adapter Kit

The answer to those GM LS-1 engine swaps where the mounts just don't line up with the proper frame location. Made of fully machined 6061 T-6 billet aluminum and includes our interlocking poly motor mounts and hardware.



Product Reference .....	6-9
Universal Products .....	10-13
Motor & Trans. Mount Charts .....	14-19
Total Kit Charts .....	20-25
Acura .....	26
AMC .....	27
Austin .....	28
BMW .....	28
Buick .....	28
Cadillac .....	29
Chevrolet Beretta, Cavalier, Cobalt, Corsica, HHR, Z-24 .....	29
Chevrolet Camaro .....	30-31
Chevrolet Chevelle, El Camino, Monte Carlo .....	31
Chevrolet Corvette .....	32-33
Chevrolet Cars- Full Size .....	33-34
Chevrolet Nova .....	34
Chevrolet /GMC Trucks- Full Size .....	35-38
Chevrolet Trucks- Mid Size Blazer, Jimmy, S-Series .....	38
Chrysler, Dodge, Plymouth .....	39-41
Dodge Trucks .....	41-42
Ford Focus .....	43
Ford Mustang .....	43-44
Ford Cars- Compact, Mid, Full Size, GT .....	45-46
Ford Thunderbird .....	46
Ford Trucks- Full Size .....	46-49
Ford Trucks- Ranger, Bronco II .....	50
Honda .....	51-52
Hyundai .....	53
Infiniti .....	53
International .....	53
Jaguar .....	53
Jeep ® .....	54-55
Lexus .....	56
Lincoln & Mercury .....	57
Mazda .....	58
MG .....	58
Mitsubishi Cars, Mitsubishi Trucks .....	59
Nissan/Datsun Cars .....	60-61
Nissan/Datsun Trucks .....	61
Oldsmobile .....	62
Pontiac / Firebird .....	63-64
Porsche .....	65
Rover .....	65
SAAB .....	65
Saturn .....	65
Scion .....	65
Subaru .....	66
Suzuki .....	67
Toyota Cars, Toyota Trucks .....	67-68
Triumph .....	69
Volkswagen .....	69
Tools & Shop Accessories .....	70
Apparel & Promotional .....	71
Where to Buy PROTHANE Products .....	71

Product categories in alphabetical order.

## Axle Pivot Bushings

PROTHANE'S special formulated Axle Pivot Bushings keep your Ford truck running straight and true. As Ford owners know, those heavy "I" Beams can quickly wear out the stock bushings. Tough enough for running off-road yet compliant enough for everyday street use.

## Body Mount Kit

One of the most cost-effective methods of improving the handling and "feel" of any vehicle is to replace the mushy and probably worn-out OEM rubber body mount bushings.

PROTHANE™ body and cab mounts provide the necessary rigidity, yet have ample resilience to keep every thing quiet. Perfect for both off-road and street use.

## Ball Joint Boots

The ball joint's smoothness of operation and service life are very much affected by dirt, moisture and other contaminants.

For this reason, PROTHANE™ ball joint boots are essential for protecting this important suspension components.

## Coil Spring Lift Spacers

An inexpensive alternative to costly suspension lift kits. These coil spring lift spacers allow your vehicle to be raised up to 2 inches while still using your stock coil springs. Available for Dodge, Ford, Jeep, Toyota, and GM vehicles.

## "C" Bushings

PROTHANE™ provides you with additional opportunities to "snug up" your suspension with heavy duty "C" bushings for use in the "jaws" of Ford strut arms. These components help provide a responsive, stable ride and eliminate the "wandering" associated with worn stock bushings. Different degrees are available for varying ride heights.

## Control Arm Bushings, Front

It is impossible to maintain the proper front suspension caster and camber when the control arms are wobbling on mushy OEM rubber bushings. PROTHANE'S design provides superior handling through optimum compliance resistance. Alignment settings are accurately maintained.



## Control Arm Bushings, Rear

A vital addition to any vehicle. Controls unwanted hop or shudder. PROTHANE™ offers complete kits for all popular two and four control arm rear applications. We offer a selection of both shelled and unshelled versions.

## Drive Train Couplers "Six Shooter™"

These trick units are patterned after our ground breaking "Six Shooter" Driveshaft Coupler. We solved the problem of weak OEM Couplers. Made of fully machined 6061 T6 billet aluminum featuring specially formulated urethane inserts providing NVH dampening that is not available with solid after market units. Sold each. Our couplers are designed as factory performance replacements and not for racing.

## Drive Train

Helping to keep the driveline properly aligned is an important benefit of PROTHANE™ polyurethane bushings. Factory bushings tend to wear out, with the resultant sloppiness, putting the driveline in a potential "bind" condition. Controlling horsepower, it benefits acceleration and handling.

## Motor Mounts

We offer a wide variety of motor mount styles. In all cases, our mounts are designed to limit the travel, reduce the chance of breakage and put the power to the wheels. All of our Motor Mount Kits feature application specific engineering. In other words, they are not universal in fit and provide you with the performance you demand. If applicable, our mounts feature a Poly-Locked "run-safe" feature, just in case you play way too hard... so you can still get back home.

## Motor Mounts Inserts

We were the first to create the solution for FWD performance cars utilizing specially formulated urethane "INSERTS". We continue the expansion of these problem solvers with innovative solutions. Improves hard start traction and shifting performance by limiting engine movement. (Mounts Not Included.)

## Motor Mounts: LS-1 Adapter Kit

Here is the answer to those LS-1 engine swaps where the mounts don't line up with the proper frame location. Made of fully machined 6061 T-6 billet aluminum & complete with all the correct hardware to complete the installation. Includes our hi-performance interlocked urethane. We offer three types of models.

- Type "A" the "Short & Wide" model. **7-519 LS-1 Motor Mount Adapter Kit (Type "A")**
- Type "B" the "Tall & Narrow" model. **7-520 LS-1 Motor Mount Adapter Kit (Type "B")**
- 7-524 LS-1 Motor Mount Adapter Kit (for '63-72 GM trucks)**

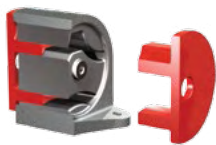

Section View

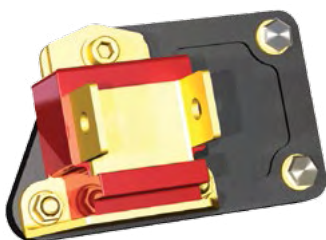

## Radiator Isolators

With four models to choose from, these four piece isolator kits for the 1968-2004 GM Cars, 1973-98 GM/GMC Trucks and Sport Utility Vehicles cover both small block and big block engine vehicles. PROTHANE'S revolutionary polyurethane compound makes these isolator mount kits impervious to chemicals and elements, unlike the stock rubber units.

## Shifter Bushings

One of the sloppiest items on front wheel drive cars can be the shifter. This is especially true if the car is getting older or has been shifted hard. Our bushings firm up your linkage while providing you with added confidence during power shifts. A very inexpensive performance enhancer!

## Spring & Shackle Bushings

In leaf spring-type suspensions there are significant forces focused on the pivot points and shackles. For this reason, it is imperative to replace the soft, blown-out OEM rubber bushings with PROTHANE™ premium grade polyurethane components.

All related sleeves, etc. are precision fabricated to assure a perfect fit.

## Heavy Duty Spring Shackle Bushing Kits

We now offer complete Heavy Duty Shackle Bushing Kits for Camaros and Mustangs.

## Spring Isolators, Coil Type

Models to fit most vehicle applications. Solves the common problem of worn or rotted OEM rubber pads. Reduces noise and looks great! Check the vehicle listings section for specific applications.

## Spring Perch

These front spring perches are a direct replacement for the 64-73 Ford Mustangs. A vast improvement in handling & less expensive than OEM to boot!  
#6-1702 64-73

## Steering Bushings

PROTHANE™ offers high performance steering bushings that will last longer and improve chassis feedback. From rack & pinion to worm gear boxes, we have a variety of applications. While most models are direct factory replacements, we also offer various rack & pinion "offset" versions for those with modified ride height.



## Spring Isolators, Leaf Style

We have applications for all the GM rear leaf type suspensions. Replaces those inferior OEM pads. A must when rebuilding the suspension or changing the rear springs. Check listings for specific applications.

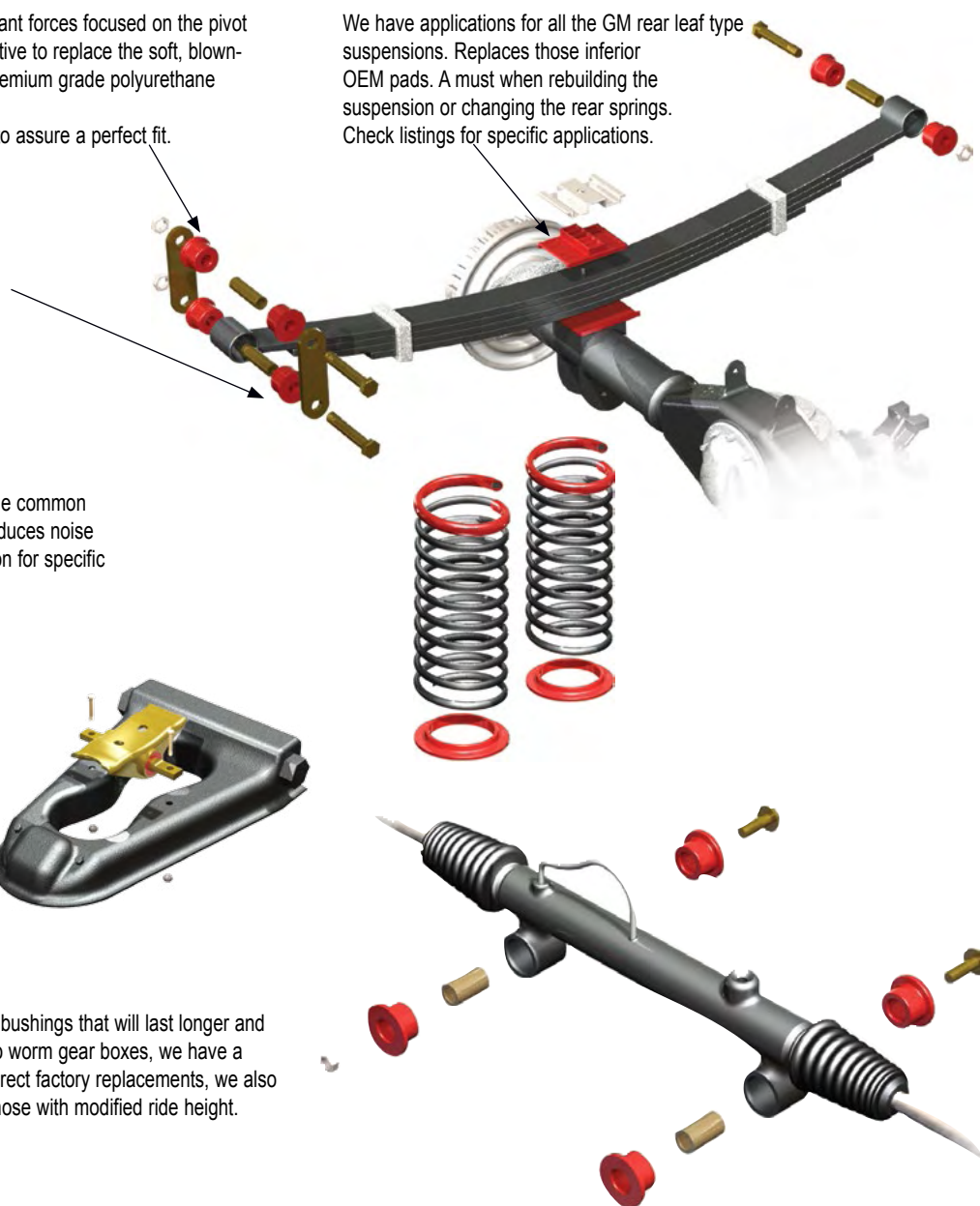



## Strut Arm/Rod Bushings

Rapid acceleration and hard braking place varying loads on the suspension, and in some applications strut rods are employed to maintain proper alignment. PROTHANE'S durable, responsive polyurethane bushings are far superior to the OEM rubber components or parts, which typically have deteriorated.

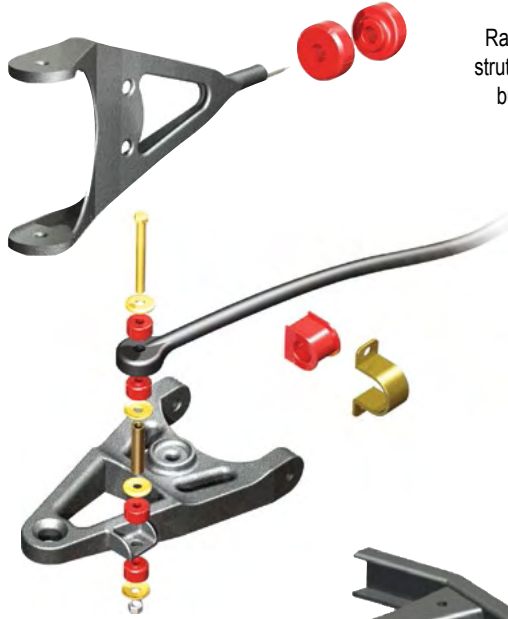

## Sway Bar & End Link Bushings

The effectiveness of OEM stabilizer (anti-roll or sway) bars can easily be enhanced through replacing the mushy stock rubber bushings with firm PROTHANE™ polyurethane bushings. They feature grooved bores, designed to hold PROTHANE'S Super Grease, for quiet operation. Also available for larger diameter high performance sway bars.

## Track Arm/Panhard Rod Bushings

Get rid of that annoying sway after installing these bushings into your vehicle's Track Arm or Panhard Rod. Specifically formulated to control any unwanted motion in the front or rear of today's straight axle vehicles. A must for any heavy-duty application or race vehicle.

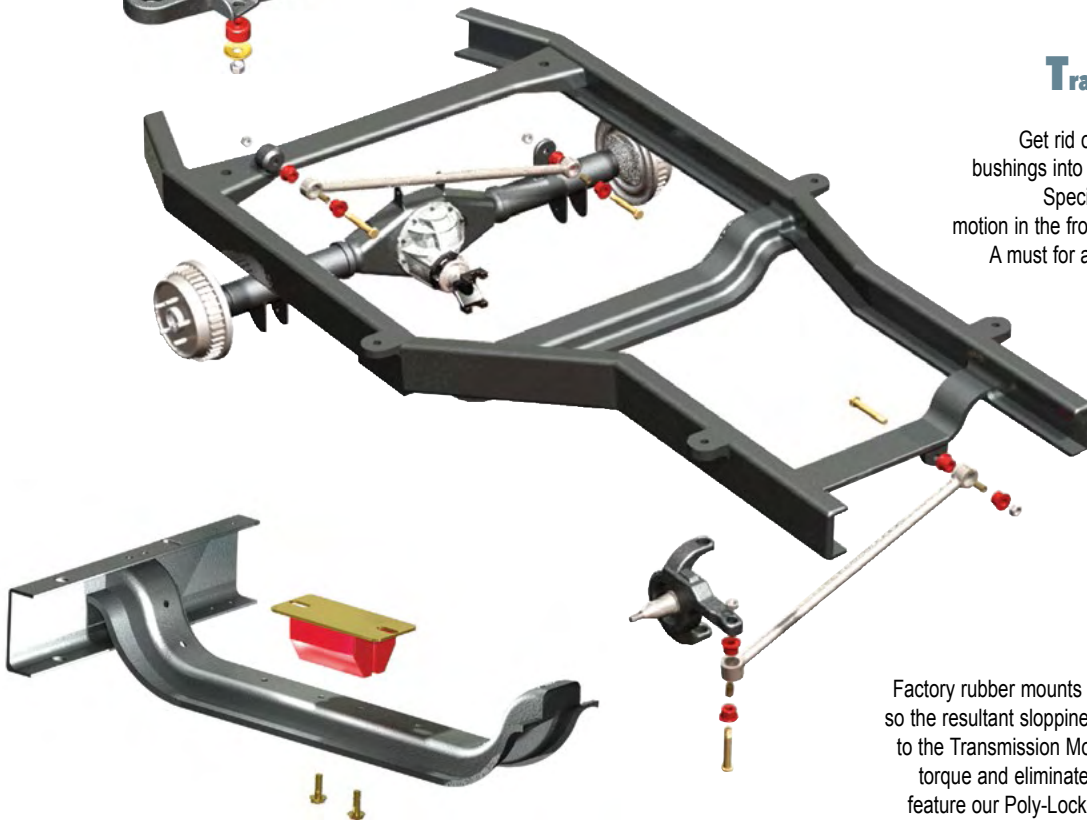

## Transmission Mounts

Factory rubber mounts were never intended to take much abuse, so the resultant sloppiness in your drivetrain can be largely traced to the Transmission Mounts. Our mounts are designed to control torque and eliminate breakage. Where applicable, our mounts feature our Poly-Locked "run-safe" interlocking device so you'll never have a broken stock mount .

## Trans Mount Custom Crossmember

We offer a complete, including custom crossmember, transmission mount kit for the '99-'04 Mustangs. Unique design in our X member provides adjustability to compensate for the varying factory tolerances. HD poly locked trans. mounts incorporates our "run safe" interlock device.

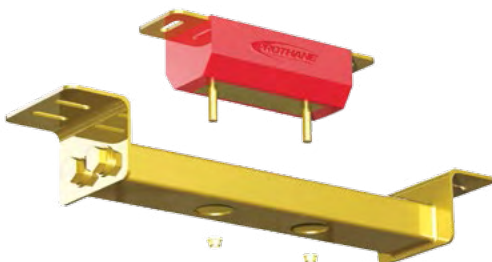

- #6-1606 Trans Mount With/ X Member 99-04
- #6-1607 Mustang X Member Only, 99-04
- #6-1608 Tremec T56 6 Spd Conversion Trans Mount into 79-98 Mustangs

# Universal Product Guide

## Universal Sway Bar Bushings

PROTHANE™ offers precision made Universal Sway Bar Bushing sets that deliver maximum performance. The same formulated performance urethane compound found in our other sway bar bushings is used here, giving you superior handling over the stock rubber units. The widest size range is available to cover all popular applications. Each pair is sold with matching heavy duty brackets to insure a perfect fit.

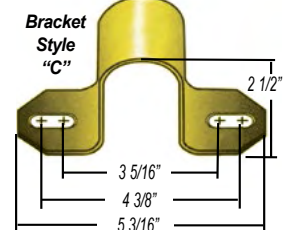
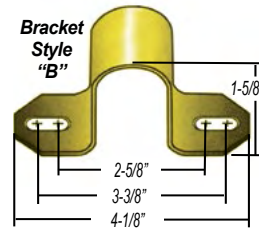
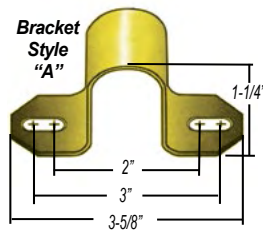

"C" Bracket not suitable for heavy duty applications



All Sway Bar Bushing Kits are sold in pairs.

BAR DIAMETER	BRACKET STYLE "A"	BRACKET STYLE "B"	BRACKET STYLE "C"	BAR DIAMETER	BRACKET STYLE "A"	BRACKET STYLE "B"
7/16"	19-1101	19-1125		16mm	19-1115	
1/2"	19-1102	19-1126		17mm	19-1116	
9/16"	19-1103	19-1127		18mm	19-1117	
5/8"	19-1104	19-1128		19mm	19-1118	
11/16"	19-1105	19-1129		20mm	19-1119	
3/4"	19-1106	19-1130		21mm	19-1120	
13/16"	19-1107	19-1131		22mm	19-1121	
7/8"	19-1108	19-1132		22mm	19-1122	
15/16"	19-1109	19-1133		24mm	19-1123	
1"	19-1110	19-1134	19-1508	25mm	19-1124	19-1141
1 1/16"		19-1135		26mm		19-1142
1 1/8"		19-1136	19-1500	27mm		19-1143
1 1/4"		19-1137	19-1501	28mm		19-1144
1 5/16"		19-1138	19-1502	29mm		19-1145
1 3/8"			19-1503	30mm		19-1146
1 7/16"			19-1504	31mm		19-1147
1 1/2"			19-1505	32mm		19-1148
1 9/16"			19-1506			
1 5/8"			19-1507			

## Universal Greaseable Sway Bar Bushings

PROTHANE™ Universal Greaseable Sway Bar Bushings offers another choice for your sway bar bushing needs. Complete with precision grease fittings and unique contoured grooves to hold in the grease. These greaseable urethane sway bar bushings offer the ease of lubrication without disassembly. Each pair includes heavy duty brackets to insure a perfect fit. See diagram for the bracket sizes.



Urethane Sway Bar Bushings require lubrication with PROTHANE Teflon Super.

All Sway Bar Bushing Kits are sold in pairs.

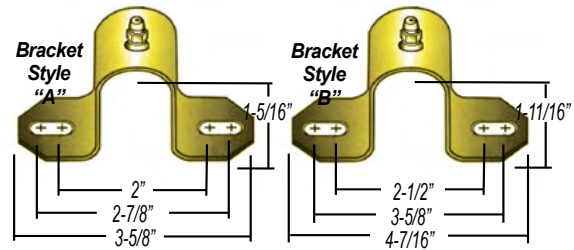

## Universal 90° Greaseable Sway Bar Bushings

PROTHANE™ Urethane 90° Universal Greaseable Sway Bar Bushings allow the ease of lubrication in tight areas without disassembly. Each pair includes heavy duty brackets. See diagram measurements shown in diagram Style "B" for the bracket size that best suits your specific requirements.



BAR DIAMETER	BRACKET STYLE "A"	BRACKET STYLE "B"	90° GREASEABLE
1/2"	19-1150	19-1169	19-1201
9/16"	19-1151	19-1170	19-1202
5/8"	19-1152	19-1171	19-1203
11/16"	19-1153	19-1172	19-1204
3/4"	19-1154	19-1173	19-1205
13/16"	19-1155	19-1174	19-1206
7/8"	19-1156	19-1175	19-1207
15/16"	19-1157	19-1176	19-1208
1"	19-1158	19-1177	19-1209
1-1/16"			19-1221
1-1/8"		19-1178	19-1210
1-1/4"		19-1179	19-1211
1-5/16"		19-1180	19-1212
16mm	19-1159		
17mm	19-1160		
18mm	19-1161		
19mm	19-1162		
20mm	19-1163		
21mm	19-1164		
22mm	19-1165		
23mm	19-1166		
24mm	19-1167		
25mm	19-1168	19-1181	19-1213
26mm	19-1182	19-1214	
27mm		19-1183	19-1215
28mm		19-1184	19-1216
29mm	19-1185		19-1217
30mm	19-1186		19-1218
31mm		19-1187	19-1219
32mm		19-1188	19-1220

## Performance Sway Bar End Link Kits

PROTHANE™ end link kits improve stability, handling and durability. If your vehicle uses standard length end links, use this guide to find the correct kit.

With the car level (not jacked up), check to make sure the stabilizer bar and control arm are parallel "B" and "C" to the application chart to find your vehicle's end links size and part number.

PART NO.	"A" LENGTH	PART NO.	"A" LENGTH
19-401	2 3/8"	19-412	4 3/4"
19-402	3"	19-413	5 3/8"
19-403	2 5/8"	19-416	5"
19-404	3 3/4"	19-417	6 1/8"
19-405	3 1/4"	19-419	7 3/8"
19-406	3 1/2"	19-420	1 3/8"
19-408	4 1/4"	19-421	2 3/4"
19-409	4 1/2"	19-424	4 5/8"

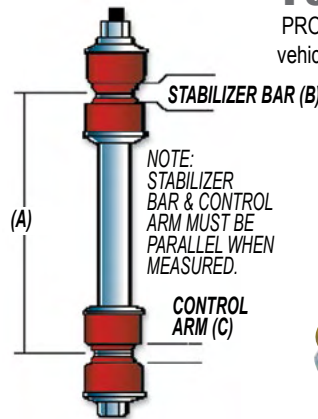

All Sway Bar End Link Kits are sold in pairs.



Combined with the Sway Bar Bushings, our End Link Bushings will make your vehicle's sway bar system more effective under all driving conditions!



PART NO.	DESCRIPTION	QTY.
19-426	Full Size Truck Style, 3/4" X 1 1/4" O.D. - Without Washers	Set Of 4
19-427	Cars And Mini Trucks 1/2" X 1" O.D. - Without Washers	Set Of 8
19-428	Cars And Mini Trucks, 5/8" X 1" O.D. - Without Washers	Set Of 8
19-429	Cars And Mini Trucks, 3/4" X 1" O.D. - Without Washers	Set Of 8
19-430	HD Set With Washers, 5/8" X 1 1/8" O.D. - With Washers	Set Of 8

## Coil Spring Isolators

The chart below lists size specifications of some of our most popular Spring Isolators. While they are designed to fit the specific vehicles listed in our catalog, they may also be utilized in other vehicles and custom applications.

PART #	O.D.	I.D.	FLANGE THICKNESS	APPLICATION	QTY.
6-1704	5.50	3.50	.250	Ford	2
6-1701	3.50	3.750	.400	Ford	4
7-1706	3.625	2.125	.275	GMC	2
1-1704	6.000	3.125	.400	AMC	2
1-1706	5.125	3.875	.185	AMC	2
4-1705	5.125	2.375	.150	Chrysler	4
6-1708	4.75	3.250	.250	Ford	2



## Coil Spring Inserts

PROTHANE™ Coil Spring Dampening Inserts are available in five (5) heights, so stacking is a practice of the past. These inserts prevent suspension bottoming and add a progressive compression rate to coil springs. Dampening inserts, when installed, should be from 1 to 3 inches less in height than the springs installed height on Chevrolet vehicles, 3/4 to 1 1/2 inches less for Dodge vehicles, and 2 to 3 inches less for Ford vehicles. Specially formulated non rebound urethane inserts offer yet another aspect to your suspension tuning by eliminating the amount of rebound after compression.

PART NO.	DESCRIPTION	PER SET
19-1701	Coil Spring Insert (2 Ring) 2 1/2" High X 3 3/4" O.D.	2
19-1702	Coil Spring Insert (3 Ring) 3 1/2" High X 3 3/4" O.D.	2
19-1703	Coil Spring Insert (4 Ring) 5" High X 3 3/4" O.D.	2
19-1704	Coil Spring Insert (6 Ring) 7 1/2" High X 3 3/4" O.D.	2
19-1705	Coil Spring Insert (8 Ring) 10 1/2" High X 3 3/4" O.D.	2

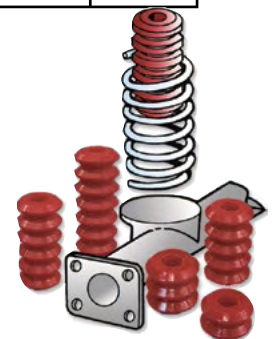

PART NO.	"A"	"B"	"C"	PART NO.	"A"	"B"	"C"
19-1711	.472"	1.200"	.950"	19-1827	.550"	1.438"	1.340"
19-1712	.590"	1.375"	.950"	19-1828	.910"	2.130"	1.100"
19-1713	.550"	1.438"	.950"	19-1829	.845"	1.690"	2.100"
19-1714	.650"	1.625"	.950"	19-1830	.500"	1.420"	.720"
19-1821	.650"	.805"	.560"	19-1831	.750"	1.700"	1.10"
19-1822	.472"	1.200"	.950"	19-1832	.770"	1.600"	1.000"
19-1823	.590"	1.375"	.950"	19-1833	.730"	1.625"	1.095"
19-1824	.550"	1.438"	.950"	19-1834	.640"	1.625"	1.445"
19-1825	.650"	1.625"	.950"	19-1835	.800"	1.800"	1.450"
19-1826	.650"	1.625"	1.15"	19-1836	.700"	1.900"	1.900"



## Boots: For Ball Joints & Tie Rod Ends

Protects Ball Joints and Tie Rod End Joints from: Dirt, Sand, Water and Snow! Retains lubrication better than rubber because hi-tech PROTHANE™ urethane will not deteriorate from grease. For the correct size, measure the joint end at the LARGEST diameter of the rod "A" socket and the total boot height "C". Select a boot which is that size or a little smaller. Sold 2 per set.

# Universal Product Guide

## Bump Stops

PART NO.	TYPE	DESCRIPTION	PER SET
19-1315	A	11/16" x 1 5/8" (Small Button)	2
19-1316	B	11/16" x 2" (Large Button)	2
19-1317	C	1 9/16" x 1 5/8" (Cone-Type)	2
19-1318	D	2 1/4" x 2 1/4" (Cone-Type With Steps)	2
19-1319	E	3/8" x 2" (Ultra-Thin)	2
19-1320	F	7/8" x 2 1/4" (Hex Shape)	2
19-1301	G	3/4" x 1 3/4" x 1 3/8" (Rectangular)	2
19-1302	H	1" x 1 3/4" x 1 7/16" (Curved Top)	2
19-1303	I	1 3/8" x 1 1/8" x 1 1/4" (Wedge)	2
19-1304	J	5/8" x 2" x 2" (Small Square)	2
19-1305	K	2" x 2" x 2" (Large Square)	2
1-1301	L	1 3/4" x 3" x 1 3/4" (Rectangle, Wedge)	2
19-1312	M	1 1/2" x 2" x 1 3/4" (Wedge)	2

PROTHANE™ offers a comprehensive selection of cone and button style bump stops, designed to accommodate your specific vehicle's needs.

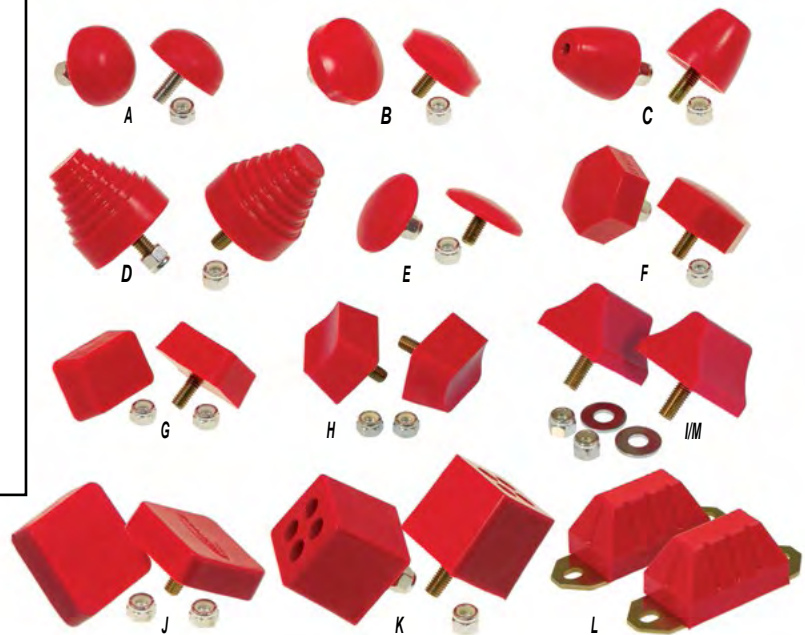

All Bump Stops are sold in pairs, as shown.

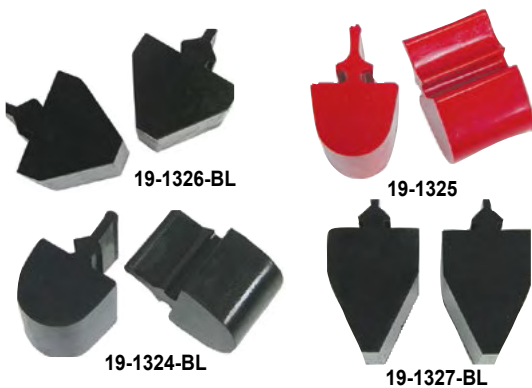

## "Pull Thru" Style Bump Stops

Direct replacement for those worn or worthless OEM units. High quality tough urethane will outlast rubber & is impervious to oils & road grime.

**19-1324** General Motors style Pull Through bump stops. Designed to fit a variety of GM models between 1978-01.

**19-1325** General Motors style Pull Through upper control arm bump stops.

**19-1326 & 16-1327** General Motors style Pull Through bump stops. Designed to fit a variety of GM models between 1978-88.

## Bump Stops (Progressive)

PROTHANE™ specially formulated, multi-mount progressive rate suspension stops prevent the damage caused when a suspension bottoms out. Add the energy absorption capabilities of urethane to the unique progressive chambers molded into the stops and you've got progressive compression rate bump stops. The multi-mount feature ensures quick, easy retrofitting, as one of the mounting systems will be ideal for your particular application. Using a unique poly-lock system, the urethane portion and mounting bracket are integrated into one rugged, versatile component.

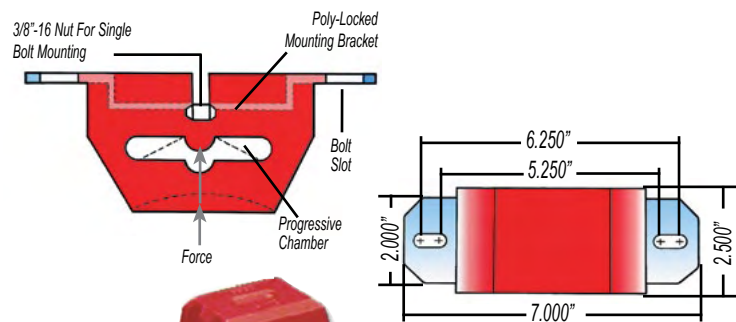

PART NO.	DESCRIPTION	PER SET
19-1314	Suspension Bump Stop 1" Multi-Mount	2
19-1306	Suspension Bump Stop 2" Multi-Mount	2
19-1307	Suspension Bump Stop 2 1/2" Multi-Mount	2
19-1308	Suspension Bump Stop 3" Multi-Mount	2
19-1309	Suspension Bump Stop 3 1/2" Multi-Mount	2
19-1310	Suspension Bump Stop 4" Multi-Mount	2
19-1311	Suspension Bump Stop 4 1/2" Multi-Mount	2

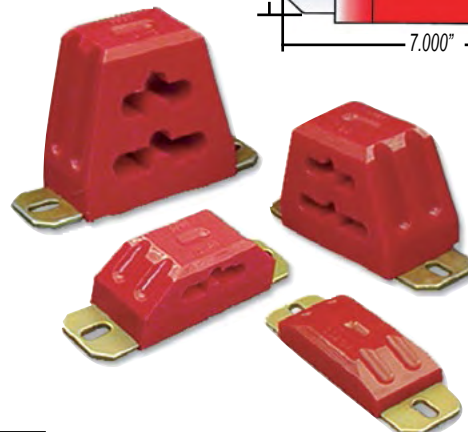

## Half Control Arm Bushing Sets

If you have upgraded your vehicle with after-market control arms that utilize urethane bushings, PROTHANE™ also provides "Half" control



arm bushing sets for the front upper and rear lower locations. These "Half" sets replace the remaining OEM rubber sets in stock vehicle control arms for the ultimate in performance and handling!

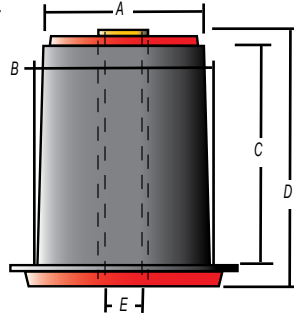

PART NO.	BUSH. QUAN.	SHELL DIM. (A)	SHELL DIM. (B)	SHELL LENGTH (C)	SLEEVE LENGTH (D)	SLEEVE ID (E)
7-271	2	1.660"	1.675"	1.975"	2.400"	.564"
7-271	2	1.900"	1.925"	2.000"	2.400"	.564"
7-272	2	1.364"	1.430"	2.000"	2.400"	.500"
7-272	2	1.900"	1.925"	2.000"	2.400"	.564"
7-273	2	1.364"	1.430"	2.000"	2.400"	.500"
7-273	2	1.658"	1.675"	1.975"	2.400"	.500"
7-274	2	1.658"	1.675"	1.975"	2.400"	.500"
7-274	2	1.905"	1.925"	2.000"	2.400"	.500"
7-275	2	1.364"	1.430"	2.000"	2.400"	.500"
7-275	2	1.37"x1.97"	1.41"x2.02"	2.054"	2.400"	.500"
7-276	2	1.447"	1.460"	2.655"	3.000"	.500"
7-276	2	1.660"	1.675"	1.980"	2.400"	.482"
7-277	4	1.865"	1.925"	2.000"	2.400"	.500"
7-278	4	1.480"	1.545"	1.240"	1.850"	.685"

## Pivot Bushings

PROTHANE™ Pivot Bushing Kits fit most common 4-Bar Systems, and offer a multitude of universal applications! Each kit includes 4 urethane bushings and 2 sleeves.



PART NO.	TUBE LENGTH	BUSHING O.D.	SLEEVE LENGTH	BOLT SIZE
19-601	1"	1 1/8"	1 27/64"	1/2"
19-602	1"	1 1/8"	1 27/64"	9/16"
19-603	1 1/4"	1 1/4"	1 3/4"	1/2"
19-604	1 1/4"	1 1/4"	1 3/4"	9/16"
19-605*	2"	1 1/2"	2 1/2"	1/2"
19-606*	2"	1 1/2"	2 1/2"	9/16"
19-607*	2 1/2"	1 1/2"	3"	1/2"
19-608*	2 1/2"	1 1/2"	3"	9/16"
19-609	2 3/8"	1.75"	3"	1/2"
19-610	2 3/8"	1.75"	3"	9/16"
19-611	2 3/8"	1.75"	3"	5/8"
19-612	2 1/2"	1.125"	1.75"	5/8"

\*Recommended Tubing: 1 3/4" X .125", 1 7/8 X .187", 2" X.250"

### STEM TYPE

PART NO.	A	B	C	D	E	F
19-901	.860"	.375"	1.270"	.600"	.120"	—
19-902	.600"	.375"	1.270"	.630"	.120"	—
19-921	.600"	.375"	1.270"	.630"	.120"	—

### 1 PIECE HOURGLASS

19-903	1.010"	.625"	1.140"	.990"	1.470"	—
19-904	1.010"	.750"	1.140"	.990"	1.470"	—
19-905	1.285"	.688"	1.480"	1.125"	1.580"	—
19-906	1.285"	.750"	1.480"	1.125"	1.580"	—

### 1 PIECE STRAIGHT (HAT)

19-907	1.285"	.625"	1.450"	.720"	1.565"	.423"
19-908	1.285"	.750"	1.450"	.720"	1.565"	.423"
19-909	1.090"	.625"	1.240"	.920"	1.400"	.240"

### 2 PIECE HOURGLASS

19-915	1.050"	.630"	1.460"	.680"	1.050"	—
19-916	1.135"	.710"	1.910"	.830"	1.040"	—
19-917	1.295"	.695"	1.470"	.800"	1.290"	—
19-918	1.310"	.750"	1.489"	.800"	1.280"	—

### 2 PIECE STRAIGHT (HAT) w/SLEEVE

19-919	1.030"	.500"	1.340"	.630"	1.620"	.500"
19-920	1.030"	12mm	1.340"	.630"	1.620"	.500"

## Shock Mount Bushings

Upgrade your new shock absorbers or breathe new life into your old ones with these PROTHANE™ urethane Shock Mounts, Eyes & Grommets.

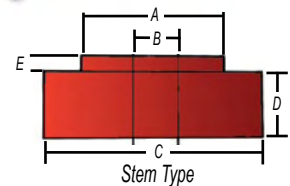
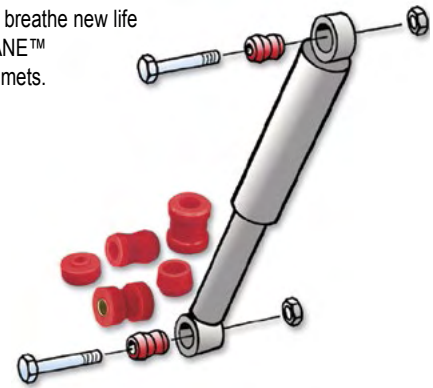
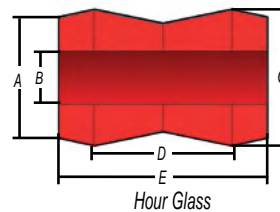
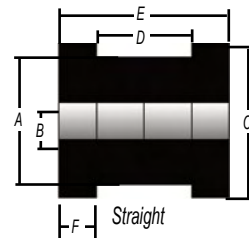

## Shock Reservoir Mounts

These PROTHANE™ urethane Shock Reservoir Mounts provide a dampening effect in between the remote shock absorbers reservoir and the mounting tubes. Available in various sizes from: 1.500" to 3.000" to accommodate all popular tube sizes.

PART NO.	DIA. 1	DIA. 2
19-1718	1.5"	2"
19-1719	1.5"	2.5"
19-1720	1.5"	3"
19-1721	2"	2"
19-1722	2.5"	2.5"

# Motor & Transmission Mount Charts

## Anatomy Of A Performance Mount Design:

### Ultimate Traction:

Our mounts are designed to eliminate driveline deflection resulting in the vehicle transmitting the horsepower to the ground.

### Tough Formula:

Tough formulation that will last the lifetime of your vehicle.

### Beats the Elements:

Impervious to deterioration caused by oil, grease and the elements.

### Precision Fit:

Matched components precisely engineered for a perfect fit to your vehicle's specific model and year.

### Superior Performance:

PROTHANE™ Urethane provides superior performance over factory rubber bushings, mounts and couplers.

### Superior Durability:

We use only the best materials and heavy-duty hardware to provide ultimate performance.

### Failsafe Feature:

All PROTHANE™ Motor and Transmission Mounts have a built-in special Interlock, that will keep them from coming apart in a catastrophic failure.

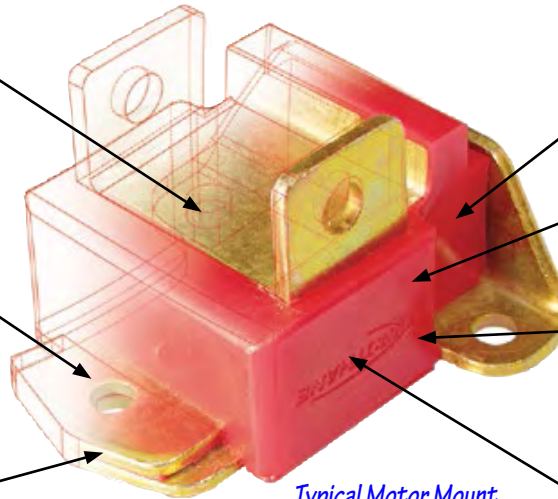

Typical Motor Mount For GM Models



## Sport Compact Motor & Transmission Mount Bushings & Inserts

(All inserts are designed for manual transmission cars, unless specified.)



Model	Year	Left Mount	Right Mount	Rear Mount	Front Mount	All Mount Combo Kits
-------	------	------------	-------------	------------	-------------	----------------------

### ACURA

Integra (GS, LS, RS)	90-91	8-510	8-511	8-512	N/A	8-1905
Integra (GS, LS, RS)	92-93	8-516	8-511	8-512	N/A	8-1908
Integra (GSR)	92-93	8-510	8-511	8-512	N/A	8-1905
Integra	94-01	8-501	8-502	8-509	N/A	8-1904

### AUDI

R8	06-12	N/A	N/A	N/A	N/A	2-1600*
R10	00-05	N/A	N/A	N/A	N/A	2-1600*

\*Motor & Transmission Mount Kit - Billet Aluminum & Urethane

Model	Year	Upper Mount	Lower Torque Strut	Front Trans. Mount	Rear Trans. Mount	All Mount Combo Kits
-------	------	-------------	--------------------	--------------------	-------------------	----------------------

### CHEVROLET

Cavalier (Non Ecotec)	95-04	7-513*	7-511*	7-514**	7-515**	N/A
Cobalt 2.0 sc, Turbo	05-07	N/A	N/A	7-516**	7-516**	N/A
Cobalt 2.2/2.4	05-07	N/A	N/A	7-517**	7-517**	N/A

\*5-Speed & Automatic / \*\*Manual Only

Model	Year	Left Mount	Right Mount	Rear Mount	Front Mount	All Mount Combo Kits
-------	------	------------	-------------	------------	-------------	----------------------

### CHRYSLER / DODGE / PLYMOUTH

Neon (Race)	95-99	4-503	4-502	N/A	4-501	4-1901
Neon (Street)	95-99	—	—	N/A	—	4-1902
Neon (Race)	00-06	N/A	—	N/A	—	4-1905*
Neon (Street)	00-06	N/A	—	N/A	—	4-1906*
Stealth	91-99	N/A	N/A	N/A	N/A	4-511

### FORD

Focus	00-06	N/A	N/A	N/A	6-502*	N/A
Focus	12-13	N/A	N/A	6-506**	N/A	N/A

### HONDA

\*Front Lower Mount \*\*Insert

Accord	90-97	N/A	N/A	8-514	N/A	N/A
Accord	94-97	N/A	N/A	8-514	8-515	8-1907
Civic/CRX	88-91	8-506	8-507	8-508	8-517	8-1903
Civic/Del Sol*	92-95	8-501†	8-502	8-503	N/A	8-1901†
Civic	96-00	8-504	8-505	8-503	N/A	8-1902
Civic Si	99-00	8-504	8-505	8-509	N/A	8-1906

\*Excluding 92-93 Si †1.6L Only

Model	Year	Left Mount	Right Mount	Rear Mount	Front Mount	All Mount Combo Kits
-------	------	------------	-------------	------------	-------------	----------------------

### HYUNDAI

Tiburon V6	00-05	N/A	N/A	28-501	28-501	N/A
------------	-------	-----	-----	--------	--------	-----

### MITSUBISHI

Eclipse / Laser / Talon, Manual Trans., FWD-AWD, Turbo & Non Turbo:						
	90-94	13-503 *	13-501 *	13-506 *	13-505 *	13-1902 *
Eclipse / Talon, Manual Trans., FWD-AWD, Turbo & Non Turbo:						
	95-99	13-503 *	13-501 *	13-504 **	13-502 **	13-1901
Eclipse 4-Cyl.	00-05	13-509 *	13-503 *	13-510 **	13-507 *	13-1904
Eclipse V6	00-05	13-509 *	13-503 *	13-508 *	13-507 *	13-1903
EVO 10	08-13	13-512 ††	13-512 ††			
3000GT	91-99	N/A	N/A	N/A	N/A	4-511

\* Bushings \*\* Inserts † Both Left & Right Locations Set

### NISSAN

Sentra	91-99	14-501	14-502	14-501	—	14-1901
200SX	95-98	14-501	14-502	14-501	—	14-1901
NX1600 / NX2000	91-96	14-501	14-502	14-501	—	14-1901
Sentra SE-R / Spec-V	02-06	—	—	14-505	14-504	—

### PONTIAC

Sunfire (Non Ecotec)	95-04	7-513*	7-511*	7-514**	7-515**	N/A
----------------------	-------	--------	--------	---------	---------	-----

\*5-Speed & Automatic / \*\*Manual Only

### SATURN

S-Car	92-00	N/A	N/A	7-510	N/A	N/A
-------	-------	-----	-----	-------	-----	-----

Model	Year	Left Mount	Lower Mount	Rear Mount	Front Mount	All Mount Combo Kits
-------	------	------------	-------------	------------	-------------	----------------------

### VOLKSWAGEN

Rabbit / Golf / GTI / Jetta	75-84	—	—	22-502	22-501	—
	76-79	22-504	—	—	—	—
	80-84	22-505	—	—	—	—
Golf II / Jetta II	85-92	—	—	22-503	—	—
New Beetle	98-10	—	22-507	—	—	—
Golf / GTI	99-10	—	22-507	—	—	—
Jetta	99-05	—	22-507	—	—	—

# Motor & Transmission Mount Charts

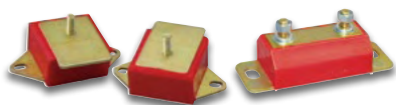

## Domestic Vehicle Motor & Transmission Mounts

(All motor mounts are sold in pairs, unless specified.)

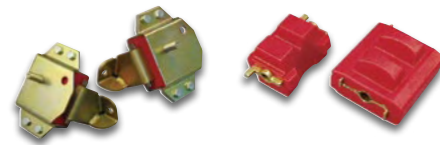

Model	Year	Engine Size	Motor Mount	Trans. Mount	Mtr./Trans. Mount Combo
-------	------	-------------	-------------	--------------	-------------------------

### AMC

All Model	64-83	6 cyl.	1-501	N/A	N/A
All Models	67-83	8 cyl.	1-503	N/A	N/A

### BUICK

Apollo/Century	73-75	250 6 cyl.	7-506	7-1604	7-1906
Century	81-82	267 8 cyl.	7-506	N/A	N/A
Century	78-80	305 8 cyl.	7-506	7-1604†	7-1906†
Century	77-79	350 8 cyl.	7-506	7-1604	7-1906
Century	81-82	267 8 cyl.	7-506	N/A	N/A
Regal	73-75	250 6 cyl.	7-506	7-1604	7-1906
Regal (Diesel)	82-84	260 6 cyl.	7-506	7-1604	7-1906
Regal	81-82	267 8 cyl.	7-506	N/A	N/A
Regal	77-78	305 8 cyl.	7-506	7-1604	7-1906
Regal	77-79	350 8 cyl.	7-506	7-1604*	7-1906*
Riveria	77-78	350 8 cyl.	7-506	N/A	N/A
Roadmaster	91-93	305/350 8 cyl.	7-506	7-1604	7-1906
Skylark	73-75	250 6 cyl.	7-506	7-1604	7-1906
Skylark	77-79	305 8 cyl.	7-506	7-1604**	7-1906**
Skylark	77-79	350 8 cyl.	7-506	7-1604	7-1906
Le Sabre	78-82	267/305 8 cyl.	7-506	7-1604	7-1906
Le Sabre	77-78	350 8 cyl.	7-506	N/A	N/A

\*w/ Auto Only /  
\*\*77-78 Only / †78-79 Only

### CHEVROLET

Bel Air	55-57	263/283 8 cyl.	7-503	N/A	N/A
Bel Air	60-72	283/350 8 cyl.	7-504	7-1604	7-1901
Bel Air	65-67	396 8 cyl.	7-504	7-1604	7-1901
Bel Air	68-69	396 8 cyl.	7-505	7-1604	7-1902
Bel Air	70-71	400 8 cyl.	7-505	7-1604	7-1902
Bel Air	70-72	402/454 8 cyl.	7-505	7-1604	7-1902
Bel Air	72-76	400 8 cyl.	7-506	7-1604	7-1906
Bel Air	73	250 6 cyl.	7-506	7-1604	7-1906
Bel Air	73-75	350 8 cyl.	7-506	7-1604	7-1906
Bel Air	73-76	454 8 cyl.	7-506	7-1604	7-1906
Biscayne	73	250 6 cyl.	7-506	7-1604	7-1906
Biscayne	66-72	250 6 cyl.	7-509	7-1604	7-1907
Biscayne	58-68	283 8 cyl.	7-504	7-1604	7-1901
Biscayne	68	307 8 cyl.	7-504	7-1604	7-1901
Biscayne	62-69	327 8 cyl.	7-504	7-1604	7-1901
Biscayne	70-72	350 8 cyl.	7-505	7-1604	7-1902
Biscayne	73-75	350 8 cyl.	7-506	7-1604	7-1906
Biscayne	70-72	454 8 cyl.	7-505	7-1604	7-1902
Biscayne	73-76	454 8 cyl.	7-506	7-1604	7-1906
Camaro	82-84	173 6 cyl.	7-506	7-1604	7-1906
Camaro	80-81	231 6 cyl.	7-506	7-1604	7-1906
Camaro	69-70	250 6 cyl.	7-504	7-1604	7-1901
Camaro	73-79	250 6 cyl.	7-506	7-1604	7-1906
Camaro	80-81	267 8 cyl.	7-506	7-1604	7-1906
Camaro	67-68	302 8 cyl.	7-504	7-1604	7-1901
Camaro	69	302 8 cyl.	7-505	7-1604	7-1902
Camaro	76-92	305 8 cyl.	7-506	7-1604	7-1906
Camaro	73	307 8 cyl.	7-506	7-1604	7-1906
Camaro	68-72	307/350 8 cyl.	7-504	7-1604	7-1901
Camaro	67-69	350 8 cyl.	7-504	7-1604	7-1901
Camaro	72-81	350 8 cyl.	7-506	7-1604	7-1906
Camaro	87-92	350 8 cyl.	7-506	7-1604	7-1906

### CHEVROLET Continued

Camaro	93-97	350 8 cyl.	7-508	7-1604	7-1909
Camaro	98-02	350 LS1	7-512	7-1604	7-1908
Camaro	67-70	396 8 cyl.	7-505	7-1604	7-1902
Camaro	70-72	400/402 8 cyl.	7-505	7-1604	7-1902
Camaro	74-76	400 8 cyl.	7-506	7-1604	7-1906
Camaro	85-89	2.8 Ltr. 6 cyl.	7-506	7-1604	7-1906
Camaro	93-95	3.4 Ltr. 6 cyl.	N/A	7-1604	N/A
Camaro	96-00	3.8 Ltr. 6 cyl.	N/A	7-1604	N/A
Camaro	10-14	6 & 8 cyl.	7-518	7-1612	N/A
Caprice	77-79	250 6 cyl.	7-506	7-1604	7-1906
Caprice	80-82	267 8 cyl.	7-506	7-1604	7-1906
Caprice	66-67	283 8 cyl.	7-504	7-1604	7-1901
Caprice	77-93	305 8 cyl.	7-506	7-1604	7-1906
Caprice	66-69	327 8 cyl.	7-504	7-1604	7-1901
Caprice	69-73	350 8 cyl.	7-505	7-1604	7-1902
Caprice	74-85	350 8 cyl.	7-506	7-1604	7-1906
Caprice	66-67	396 8 cyl.	7-504	7-1604	7-1901
Caprice	68-69	396 8 cyl.	7-505	7-1604	7-1902
Caprice	74-76	400 8 cyl.	7-506	7-1604	7-1906
Caprice	71-72	402 8 cyl.	7-505	7-1604	7-1902

Hidden INTERLOCKING

feature of our Motor and

Transmission Mounts—

The internal “run safe”

INTERLOCKS are

engineered to prevent

breakage at the worst

possible time! Great for high

torque and performance applications.

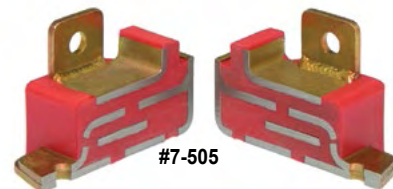

#7-505



#6-1604

GM Style Motor Mounts:

#7-504 & #7-505

GM Style Trans. Mount:

#7-1604

Ford Style

Transmission Mounts:

#6-1604, #6-1605, #6-1608

Mopar Style Transmission Mount: #4-1602

Jeep Style Mounts: #1-501, 1-1601, 1-1603

3 Hole Mounting Feature of our GM

Style Transmission Mount #7-1604.

This one part kit allows multiple

mounting applications, either for a

factory chassis or Hot Rods.



#7-1612 '10-'14 Chevy  
Camaro Billet Aluminum and  
Urethane Transmission Mount Kit

# Motor & Transmission Mount Charts

## Domestic Vehicle Motor & Transmission Mounts

Model	Year	Engine Size	Motor Mount	Trans. Mount	Mtr./Trans. Mount Combo
-------	------	-------------	-------------	--------------	-------------------------

### CHEVROLET

Chevelle	73-77	250 6 cyl.	7-506	7-1604	7-1906
Chevelle	64-67	283 8 cyl.	7-504	7-1604	7-1901
Chevelle	76-77	305 8 cyl.	7-506	7-1604	7-1906
Chevelle	68-73	307 8 cyl.	7-504	7-1604	7-1901
Chevelle	64-69	327 8 cyl.	7-504	7-1604	7-1901
Chevelle	70-72	350 8 cyl.	7-505	7-1604	7-1902
Chevelle	73-75	350 8 cyl.	7-506	7-1604	7-1906
Chevelle	65-67	396 8 cyl.	7-504	7-1604	7-1901
Chevelle	68-72	396/400 8 cyl.	7-505	7-1604	7-1902
Chevelle	73-75	400 8 cyl.	7-506	7-1604	7-1906
Chevelle	70-72	402/454 8 cyl.	7-505	7-1604	7-1902
Chevelle	73-75	454 8 cyl.	7-506	7-1604	7-1906
Chevy SS	14-17	8 cyl.	7-527	7-1615	N/A
Corvette	63-68	327 8 cyl.	7-504	7-1604	7-1901
Corvette	63-82	350 8 cyl.	7-504	7-1604	7-1901
Corvette	65-67	396 8 cyl.	7-504	7-1604	7-1901
Corvette	80	305 8 cyl.	7-504	7-1604	7-1901
Corvette	84-91	350 8 cyl.	7-522	N/A	N/A
Corvette	92-96	8 cyl.	7-526	N/A	N/A
Corvette	97-13	8 cyl.	7-525	N/A	N/A
El Camino	65-69	396 8 cyl.	7-504	7-1604	7-1901
El Camino	64-68	327 8 cyl.	7-504	7-1604	7-1901
El Camino	73-77	250 6 cyl.	7-506	7-1604	7-1906
El Camino	79-82	267 8 cyl.	7-506	7-1604	7-1906
El Camino	64-67	283 8 cyl.	7-504	7-1604	7-1901
El Camino	79-87	305 8 cyl.	7-506	7-1604	7-1906
El Camino	68-73	307 8 cyl.	7-504	7-1604	7-1901
El Camino	70-72	350 8 cyl.	7-505	7-1604	7-1902
El Camino	73-81	350 8 cyl.	7-506	7-1604	7-1906
El Camino	68-73	396/400 8 cyl.	7-505	7-1604	7-1902
El Camino	70-73	400 8 cyl.	7-505	7-1604	7-1902
El Camino	70-72	454 8 cyl.	7-505	7-1604	7-1902
Impala	73-79	250 6 cyl.	7-506	7-1604	7-1906
Impala	80-82	267 8 cyl.	7-506	7-1604	7-1906
Impala	58-68	283 8 cyl.	7-504	7-1604	7-1901
Impala	77-85	305 8 cyl.	7-506	7-1604	7-1906
Impala	63-69	327 8 cyl.	7-504	7-1604	7-1901
Impala	69-72	350 8 cyl.	7-505	7-1604	7-1902
Impala	73-83	350/400 8 cyl.	7-506	7-1604	7-1906
Impala	74-76	400 8 cyl.	7-506	7-1604	7-1906

Model	Year	Engine Size	Motor Mount	Trans. Mount	Mtr./Trans. Mount Combo
-------	------	-------------	-------------	--------------	-------------------------

### CHEVROLET

Malibu	68-70	396 8 cyl.	7-505	7-1604	7-1902
Malibu	69-72	350 8 cyl.	7-505	7-1604	7-1902
Malibu	70-73	400 8 cyl.	7-505	7-1604	7-1902
Malibu	70-72	454 8 cyl.	7-505	7-1604	7-1902
Malibu	71-73	307 8 cyl.	7-504	7-1604	7-1901
Malibu	73-81	350 8 cyl.	7-506	7-1604	7-1906
Malibu	73-79	250 6 cyl.	7-506	7-1604	7-1906
Malibu	73-75	454 8 cyl.	7-506	7-1604	7-1906
Malibu	74-76	400 8 cyl.	7-506	7-1604	7-1906
Malibu	77-81	305 8 cyl.	7-506	7-1604	7-1906
Malibu	79-82	267 8 cyl.	7-506	7-1604	7-1906
Malibu (Diesel)	82-83	260 6 cyl.	7-506	7-1604	7-1906
Monte Carlo	70-72	350 8 cyl.	7-505	7-1604	7-1902
Monte Carlo	70-73	400 8 cyl.	7-505	7-1604	7-1902
Monte Carlo	70-72	454 8 cyl.	7-505	7-1604	7-1902
Monte Carlo	73-81	350 8 cyl.	7-506	7-1604	7-1906
Monte Carlo	74-76	400 8 cyl.	7-506	7-1604	7-1906
Monte Carlo	75-79	250 6 cyl.	7-506	7-1604	7-1906
Monte Carlo	79-82	267 8 cyl.	7-506	7-1604	7-1906
Monte Carlo	79-88	305 8 cyl.	7-506	7-1604	7-1906
Monte Carlo (Diesel)	82-83	260 6 cyl.	7-506	7-1604	7-1906
Nova	62-67	283 8 cyl.	7-504	N/A	N/A
Nova	68-73	307 8 cyl.	7-504	7-1604	7-1901
Nova	69-72	350 8 cyl.	7-504	7-1604	7-1901
Nova	73-79	350 8 cyl.	7-505	7-1604	7-1902
Nova	73-79	250 6 cyl.	7-506	7-1604	7-1906
Nova	75-76	262 8 cyl.	7-506	7-1604	7-1906
Nova	77-79	305 8 cyl.	7-506	7-1604	7-1906

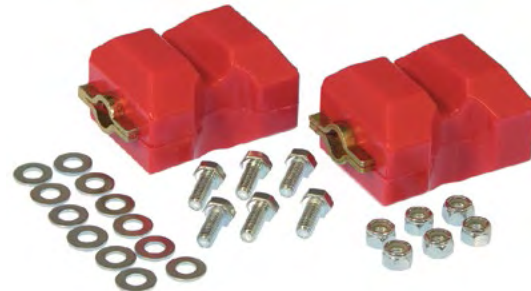

#7-522 Corvette '84-'91 Motor Mount Kit



#7-1901-BL  
Motor & Transmission Mount Combo Kit



#7-1604 Transmission Mount Kit



#7-525-BL  
'97-'13 Corvette  
Billet Aluminum and  
Urethane Motor Mount Kit



#7-526  
'92-'96 Corvette  
Billet Aluminum and  
Urethane Motor Mount Kit

#### TECH TIP:

Old motor mounts should always be replaced in pairs to prevent torque damage.



# Motor & Transmission Mount Charts

## Domestic Vehicle Motor & Transmission Mounts

Model	Year	Engine Size	Motor Mount	Trans. Mount	Mtr./Trans. Mount Combo
-------	------	-------------	-------------	--------------	-------------------------

### CHRYSLER/DODGE/PLYMOUTH

"A" Body	60-87	ALL	See Below	4-1603	See Below
"A" Body	67-72	ALL	See Below	4-1602	See Below
"B" Body	66-70	ALL	N/A	4-1602	N/A
"B" Body	62-79	ALL	See Below	4-1603	See Below
"C" Body	65-78	ALL	See Below	4-1603	See Below
"E" Body	70-74	ALL	See Below	4-1603	See Below
"F" "M" & "J" BODY	76-80	ALL	See Below	4-1603	See Below
Chrysler					
Cordoba, 5th Ave.	75-89	318 8 cyl.	4-504	4-1603	4-1903
Imperial, LeBaron	75-89	318 8 cyl.	4-504	4-1603	4-1903
New Yorker, Newport	75-89	318 8 cyl.	4-504	4-1603	4-1903
300	75-89	318 8 cyl.	4-504	4-1603	4-1903
300c	06-11	5.7 L & 6.1 L	4-512	N/A	N/A
300c	12-15	5.7 L & 6.1 L	4-506	N/A	N/A
Cordoba, LeBaron	74-80	360 8 cyl.	4-504	4-1603	4-1903
New Yorker, Newport	74-80	360 8 cyl.	4-504	4-1603	4-1903
Cordoba, New Yorker	72-78	400 8 cyl.	4-504	4-1603	4-1903
Newport	72-78	400 8 cyl.	4-504	4-1603	4-1903
Imperial, Newport	74-78	440 8 cyl.	4-504	4-1603	4-1903
Dodge					
Aspen, Diplomat	73-80	360 8 cyl.	4-504	4-1603	4-1903
Aspen, Diplomat	73-89	318 8 cyl.	4-504	4-1603	4-1903
Challenger, Coronet	70-76	360 8 cyl.	4-504	4-1603 *	4-1903 *
Challenger, Coronet	70-76	318 8 cyl.	4-504	4-1603 *	4-1903 *
Challenger	06-11	5.7L & 6.0L	4-512	N/A	N/A
Challenger	12-15	5.7L & 6.0L	4-506	N/A	N/A
Charger	73-77	360 8 cyl.	4-504	4-1603 *	4-1903 *
Charger, Coronet	74-77	400 8 cyl.	4-504	4-1603 **	4-1903 **
Charger	06-11	5.7L & 6.1 L	4-512	N/A	N/A
Charger	12-15	5.7L & 6.1 L	4-512	N/A	N/A
Dart	71-72	340 8 cyl.	N/A	4-1602	N/A
Dart	73-76	318 8 cyl.	4-504	4-160	4-1903
Dart	73	340 8 cyl.	N/A	4-1603	N/A
Dart	73-76	360 8 cyl.	4-504	4-1603	4-1903
Magnum, Mirada	73-80	360 8 cyl.	4-504	4-1603	4-1903
Magnum, Mirada	73-89	318 8 cyl.	4-504	4-1603	4-1903
Magnum, Royal	74-78	400 8 cyl.	4-504	4-1603	4-1903
Magnum	06-11	5.7L & 6.1 L	4-512	N/A	N/A
Monaco, Royal	73-89	318 8 cyl.	4-504	4-1603	4-1903
Monaco, Royal	73-80	360 8 cyl.	4-504	4-1603	4-1903
St. Regis	73-80	360 8 cyl.	4-504	4-1603	4-1903
St. Regis	73-89	318 8 cyl.	4-504	4-1603	4-1903
Plymouth					
Barracuda	70-74	318 8 cyl.	N/A	4-1603	N/A
'Cuda	70-74	340 8 cyl.	N/A	4-1603	N/A
Fury	68-73	440 8 cyl.	4-504	4-1603	4-1903
Fury, Grand Fury	73-89	318 8 cyl.	4-504	4-1603	4-1903
Fury, Grand Fury	74-80	360 8 cyl.	4-504	4-1603	4-1903
Fury, Grand Fury	73-78	400 8 cyl.	4-504	4-1603	4-1903
Satellite	64-74	318 8 cyl.	4-504	4-1603	4-1903
Scamp, Valiant	73-76	318 8 cyl.	4-504	4-1603	4-1903
Scamp, Valiant	74-76	360 8 cyl.	4-504	4-1603	4-1903
Volare	73-89	318 8 cyl.	4-504	4-1603	4-1903
Volare	74-80	360 8 cyl.	4-504	4-1603	4-1903

\* '73 & 74 Only

\*\* '74 Only

\*\*\* Bullet Style Motor Mounts

Model	Year	Engine Size	Motor Mount	Trans. Mount	Mtr./Trans. Mount Combo
-------	------	-------------	-------------	--------------	-------------------------

### DODGE TRUCKS

<b>Trucks 2WD</b>					
1/2, 3/4 & 1 Ton	69-87	3.7L 6 / 5.2L V8	N/A	4-1603	N/A
1/2, 3/4 & 1 Ton	72-87	5.9L V8	N/A	4-1603	N/A
1/2, 3/4 & 1 Ton	71-78	6.6L V8	N/A	4-1603	N/A
1/2, 3/4 & 1 Ton	73-78	7.2L V8	N/A	4-1603	N/A
All 5.9	94-02	Cummins Diesel	4-507 *	N/A	N/A
All	94-02	3.9, 5.2, 5.9 Ltr., Cummins Diesel	4-510	N/A	N/A
All 5.9	04-08	Cummins Diesel	4-508	N/A	N/A
All 6.7	07-09	Cummins Diesel	4-509	N/A	N/A
<b>Trucks 4WD</b>					
1/2 Ton	69-87	3.7L 6	N/A	4-1604	N/A
1/2 Ton	89-93	3.9L 6	N/A	4-1604	N/A
1/2 Ton	70-73	5.2L V8	N/A	4-1604	N/A
1/2, 3/4 Ton	74-93	5.2L V8	N/A	4-1604	N/A
1/2, 3/4 Ton	70-93	5.9L V8	N/A	4-1604	N/A
1/2, 3/4 Ton	74-78	6.6L / 7.2L V8	N/A	4-1603	N/A
3/4 Ton	69-80	3.7L 6	N/A	4-1604	N/A
3/4 Ton	72-73	5.2L V8	N/A	4-1603	N/A
1 Ton	70-78	3.7L 6	N/A	4-1604	N/A
1 Ton	70-80	5.2L V8	N/A	4-1604	N/A
1 Ton	70-93	5.9L V8	N/A	4-1604	N/A
1 Ton	76-78	6.6L V8	N/A	4-1603	N/A
1 Ton	75-78	7.2L V8	N/A	4-1603	N/A
All	94-02	3.9, 5.2, 5.9 Ltr., Cummins Diesel	4-510	N/A	N/A

\* Insert Kit Only

Model	Year	Engine Size	Motor Mount	Trans. Mount	Mtr./Trans. Mount Combo
-------	------	-------------	-------------	--------------	-------------------------

### FORD (Additional Transmission Mount Listing On Pages 43 to 46)

Fairlane	63-67	289 8 cyl.	6-503 1	6-1605 †	6-1904 † <sup>1</sup>
Falcon	66-68	289 8 cyl.	6-503 1	6-1605	6-1904 1
Torino	68-71	302 / 351 8 cyl.	6-503 1~	6-1605	6-1904 1
Mustang	65	260 / 289 8 cyl.	6-503 *1	6-1605	6-1904 *1
Mustang	66-68	289 8 cyl.	6-503 1	6-1605	6-1904 1
Mustang	68-73	302 8 cyl.	6-503 1	6-1605	6-1904 1
Mustang	69-73	351 8 cyl.	6-503 1~	6-1605	6-1904 1
Mustang (T-56 Trans.)	79-98	V8	See Below	6-1608 **	N/A
Mustang	84-95	5.0 Ltr. V8	6-501	6-1604	6-1905
Mustang	96-98	4.6 / 5.4 V8	6-50 4	6-1604 2	N/A
Mustang	99-04	4.6 / 5.4 V8	6-50 4	6-1606	N/A
Mustang	99-04	4.6 / 5.4 V8	N/A	6-1607 3	N/A
Mustang	05-17	4.0 / 4.6 6 & 8 Cyl.	6-505	6-1615 4	N/A
Thunderbird	80-85	5.0 Ltr. 8 Cyl.	6-501	6-1604	6-1905

(Note: Any of the above listed engines will also fit any of the listed years.)

1 Will not fit factory type Hi-Po exhaust manifolds 2 Does not fit '96-98 GT manual transmission 3 #6-1607 is a X-member only 4 #6-1615 fits 2015 only \* Requires use of '66-70 frame brackets † Fits '65-67 only \*\* Conversion mount T-56 6-Speed (may require customer fabrication)

~ 6-503 fits Winsor 351 not Cleveland engines

**#4-512 Chrysler LX Chassis Billet Aluminum and Urethane Motor Mounts Fits: '06-'11 Challenger, Charger, 300c and Magnum with 5.7L and 6.1L.**



**#6-1905-BL Mustang '69-'73 Motor & Transmission Mount Combo Kit**



**#6-505-BL Billet Aluminum and Urethane Bullet Motor Mount Kit for '05-'17 Mustangs with 4.0L & 4.6L**



# Motor & Transmission Mount Charts

## Domestic Vehicle Motor & Transmission Mounts

Model	Year	Engine Size	Motor Mount	Trans. Mount	Mtr./Trans. Mount Combo
-------	------	-------------	-------------	--------------	-------------------------

Model	Year	Engine Size	Motor Mount	Trans. Mount	Mtr./Trans. Mount Combo
-------	------	-------------	-------------	--------------	-------------------------

### GM TRUCKS

<b>Trucks 2WD</b>					
C-10 thru C-30	63-69	230 6 cyl.	7-509	7-1604	7-1907
C-10	60-62	235 6 cyl.	7-504	N/A	N/A
C-10 thru C-30	63-72	230/250 6 cyl.	7-509	N/A	N/A
C-10 thru C-30	66-72	250 6 cyl.	7-509	7-1604	7-1907
C-10 thru C-30	73-84	250 6 cyl.	7-506	7-1604	7-1906
C-10 thru C-30	60-62	283 8 cyl.	7-504	7-1604	7-1901
C-10 thru C-30	63-72	283/292 8 cyl.	7-509	7-1604	7-1907
C-10 thru C-30	77-86	305 8 cyl.	7-506	7-1604	7-1906
C-10 thru C-30	65-72	307 8 cyl.	7-509	7-1604	7-1907
C-10 thru C-30	73	307 8 cyl.	7-506	7-1604	7-1906
C-10 thru C-30	65-72	327/350 8 cyl.	7-509	7-1604	7-1907
C-10 thru C-30	63-72	350 8 cyl.	7-509	N/A	N/A
C-10 thru C-30	73-87	350/400	7-506	7-1604	7-1906
C-10 thru C-30	85-86	454 8 cyl.	7-507	7-1604	7-1905
C-10 thru C-30	88-98	454 8 cyl.	7-507	7-1604	7-1905
C-30 thru C-35	73-86	292 6 cyl.	7-506	7-1604	7-1906
C1500 thru C-25	88-98	305 8 cyl.	7-507	7-1604*	7-1905*
C1500 thru C-35	88-98	350 8 cyl.	7-507	7-1604	7-1905
S10	85-00	4.3 Ltr. 6 cyl.	7-521	N/A	N/A
Jimmy	85-00	4.3 Ltr. 6 cyl.	7-521	N/A	N/A
*w/Auto. Only					
<b>Trucks 4WD</b>					
K-10 thru K-30	63-69	230 6 cyl.	7-509	N/A	N/A
K-10 thru K-30	66-72	250 6 cyl.	7-509 1/2ton	N/A	N/A
K-10 thru K-30	73-84	250 6 cyl.	7-506 1/2ton	N/A	N/A
K-10 thru K-30	63-67	283 8 cyl.	7-506	N/A	N/A
K-10 thru K-30	63-72	292 6 cyl.	7-509	N/A	N/A
K-10 thru K-30	65-72	307 8 cyl.	7-509	7-1601††	7-1910††
K-10 thru K-30	73	307 8 cyl.	7-506	7-1601	7-1903
K-10 thru K-30	69-72	350 8 cyl.	7-509	7-1601††	7-1910††
K-10 thru K-30	75-84	400 8 cyl.	7-506	7-1601	7-1903
K-10 thru K-30	88-98	454 8 cyl.	7-507	N/A	N/A
K-10 thru K-30	73-84	250 6 cyl.	7-506	7-1601†	7-1903†
K-10 thru K-30	73-84	292 6 cyl.	7-506	7-1604*	7-1906*
K-10 thru K-30	77-87	305 8 cyl.	7-506	7-1601**	7-1903**
K-10 thru K-30	79-87	350 8 cyl.	7-506	7-1601†	7-1903†
K-10 thru K-30	68-72	396 8 cyl.	7-509	7-1604	7-1907
K-20 thru K-30	79-87	454 8 cyl.	7-507	7-1601†	7-1904†
K1500 thru K2500	88-98	305 8 cyl.	7-507	N/A	N/A
K1500 thru K2500	88-98	350 8 cyl.	7-507	N/A	N/A
S10	85-00	4.3 Ltr. 6 cyl.	7-521	N/A	N/A
Jimmy	85-00	4.3 Ltr. 6 cyl.	7-521	N/A	N/A
*w/Auto. Only					
**77-84 Only					
†79-84 Only					
††68-72 Only					

<b>Suburban 2WD</b>					
C-10 thru C-30	73-84	250 6 cyl.	7-506	7-1604	7-1906
C-10 thru C-30	77-86	305 8 cyl.	7-506	7-1604	7-1906
R-10 thru R-30	87-90	350 8 cyl.	7-506	7-1604	7-1906
R-10 thru R-30	87-91	454 8 cyl.	7-507	7-1604	7-1905
R-2500 thru K-3500	92-98	350 8 cyl.	7-507	7-1604	7-1905
C-10/20,R-10/20,R1500/2500	63-69	230 6 cyl.	7-509	7-1604	7-1907
C-10/20,R-10/20,R1500/2500	66-72	250 6 cyl.	7-509	7-1604	7-1907
C-10/20,R-10/20,R1500/2500	87-89	292 6 cyl.	7-506	7-1604	7-1906
C-10/20,R-10/20,R1500/2500	85-96	454 8 cyl.	7-507	7-1604	7-1905
<b>Suburban 4WD</b>					
K-10 thru K-30	73-84	250 6 cyl.	7-506	7-1601†	7-1903†
K-10 thru K-30	77-86	305 8 cyl.	7-506	7-1601**	7-1903**
V-10 thru V-30	87-91	454 8 cyl.	7-507	N/A	N/A
K-10/20 & V-10/20	63-69	230 6 cyl.	7-509	N/A	N/A
K-10/20 & V-10/20	66-72	250 6 cyl.	7-509	N/A	N/A
K-10/20 & V-10/20	87-89	292 6 cyl.	7-506	N/A	N/A
K-10/20 & V-10/20	80-91	350 8 cyl.	7-506	N/A	N/A
K-10/20 & V-10/20	92-98	350 8 cyl.	7-507	N/A	N/A
K-10/20 & V-10/20	85-96	454 8 cyl.	7-507	N/A	N/A
<b>Blazer 2WD</b>					
C-10	66-72	250 6 cyl.	7-509	7-1604	7-1907
C-10	73-82	250 6 cyl.	7-506	7-1604	7-1906
C-10	65-72	307 8 cyl.	7-509	7-1604	7-1907
C-10	73	307 8 cyl.	7-506	7-1604	7-1906
C-10	68-72	350 8 cyl.	7-509	7-1604	7-1907
C-10	73-87	350 8 cyl.	7-506	7-1604	7-1906
C-10	88-92	350 8 cyl.	7-507	7-1604	7-1905
<b>Blazer 4WD</b>					
K-10 thru K-30	73-84	292 6 cyl.	7-506	7-1604*	7-1906*
K-10 thru K-30	77-87	305 8 cyl.	7-506	7-1601**	7-1903**
K-10	66-72	250 6 cyl.	7-509	N/A/N/A	
K-10	73-82	250 6 cyl.	7-506	N/A/N/A	
K-10	77-84	305 8 cyl.	7-506	N/A/N/A	
K-10	65-72	307 8 cyl.	7-509	N/A/N/A	
K-10	73	307 8 cyl.	7-506	N/A/N/A	
K-10	68-72	350 8 cyl.	7-509	N/A/N/A	
K-10	73-87	350 8 cyl.	7-506	N/A/N/A	
K-10	88-94	350 8 cyl.	7-507	N/A/N/A	
K-10	75-78	400 8 cyl.	7-506	N/A/N/A	
<b>Vans</b>					
G-10 thru G-30	77-90	305 / 250	7-506	7-1604	7-1906
G-10 thru G-30	64-67	153 / 194	7-509	7-1604***	7-1907***
G-10 thru G-30	60-62	235 6 cyl.	7-504	7-1604†	7-1901†
G-10 thru G-30	66-70	250 6 cyl.	7-509	7-1604	7-1907
G-10 thru G-30	71-84	250 6 cyl.	7-506	7-1604	7-1906
G-10 thru G-30	68-71	307 8 cyl.	7-509	7-1604	7-1907
G-10 thru G-30	72-81	307 / 400	7-506	7-1604	7-1906
G-10 thru G-30	88-98	454 8 cyl.	7-507	7-1604	7-1905
Astro	85-00	4.3 Ltr. 6 cyl.	7-521	N/A	N/A
Safari	85-00	4.3 Ltr. 6 cyl.	7-521	N/A	N/A
*w/Auto. Only					
**74-84 Only					
***1/2 Ton Only					
†3/4 Ton Only					

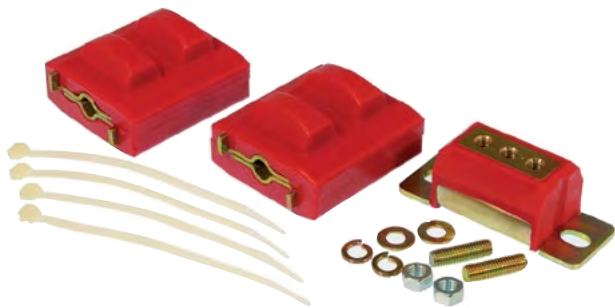

#7-1903 Motor & Transmission Mount Combo Kit

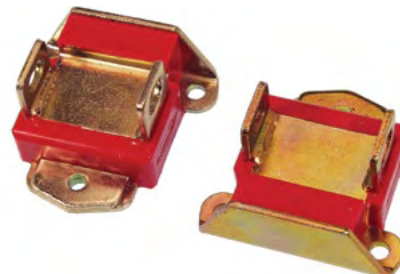

#7-504 Motor Mount Chevy (Short & Wide) fits various GM Cars & Trucks

# Motor & Transmission Mount Charts

## Domestic Vehicle Motor & Transmission Mounts



#7-507-BL Motor Mount Kit

Model	Year	Engine Size	Motor Mount	Trans. Mount	Mtr./Trans. Mount Combo
-------	------	-------------	-------------	--------------	-------------------------

### JEEP®

All Models	67-92	AMC 8 cyl.	1-503	N/A	N/A
CJ5,CJ7, CJ8	72-86	258 6 cyl.	1-501	7-1604	1-1904††
Cherokee, Wagoneer	72-83	360 8 cyl.	1-503	7-1604	1-1905
Cherokee, Wagoneer	74-85	258 6 cyl.	1-501	7-1604†	1-1904†
Cherokee (XJ)	87-02	6 cyl.	1-502	N/A	N/A
Cherokee (XJ) NEW	87-99	4.0 6 cyl.	N/A	1-1603***	N/A
Cherokee (MJ)	87-93	6 cyl.	1-502	N/A	N/A
Grand Wagoneer	80-92	6 cyl.	1-501*	7-1604	1-1904*
Grand Wagoneer	84-91	360 8 cyl.	1-503	7-1604	1-1905
J Series Pickup	63-87	232 6 cyl.	N/A	7-1604**	N/A
J Series Pickup	75-87	360 8 cyl.	1-503	7-1604	1-1905
Wrangler (YJ)	87-96	6 cyl.	1-502	7-1604	1-1906††
Wrangler (TJ)	97-06	6 cyl.	1-502	1-1601	1-1903

\*84-91 Only \*\*4WD Only \*\*\* Auto Trans. †74-83 Only  
††Complete Drive Train Kit available, see listings on pg. 52.

#1-1603 Jeep XJ '87-99 Auto Trans. Mount with Metal Polylock

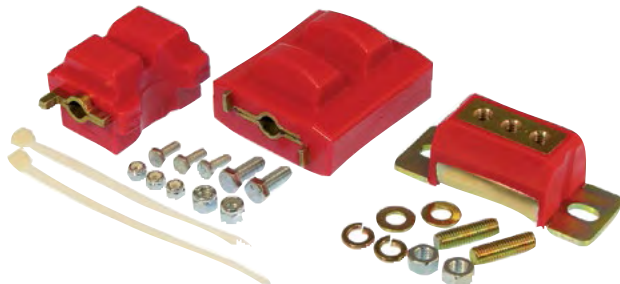
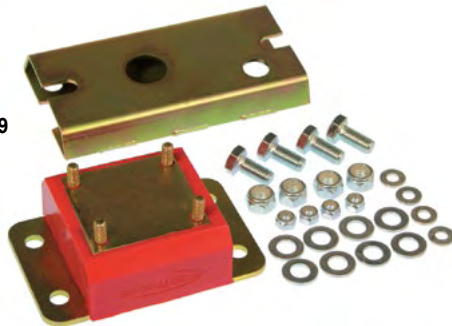

#7-1909 Motor & Transmission Mount Combo Kit

**TECH TIP:**  
Old motor mounts should always be replaced in pairs to prevent torque damage.

Model	Year	Engine Size	Motor Mount	Trans. Mount	Mtr./Trans. Mount Combo
-------	------	-------------	-------------	--------------	-------------------------

### LINCOLN/MERCURY

Comet	63-64	260 8 cyl.	6-503**1	N/A	N/A
Comet	63-65	289 8 cyl.	6-503**1	N/A	N/A
Comet	66-69	289 8 cyl.	6-5031	6-1605	6-19041
Comet	68-70	302 8 cyl.	6-5031	6-1605††	6-1904††1
Continental	82-87	5.0Ltr. 8 cyl.	6-501	N/A	N/A
Cougar	67-68	289 8 cyl.	6-5031	6-1605	6-19041
Cougar	69-72	351 8 cyl.	6-5031	6-1605	6-19041
Cougar	67-69	390 8 cyl.	6-5031	6-1605	6-19041
Cougar	68	427 8 cyl.	6-5031	6-1605	6-19041
Cougar	68-70	428 8 cyl.	6-5031	6-1605	6-19041
Cougar	80-82	5.0Ltr 8 cyl.	6-501	6-1604	6-1905
Mark VII	84-92	5.0Ltr. 8 cyl.	6-501	N/A	N/A
Montego	69-71	351 8 cyl.	6-5031	N/A	N/A

1Will not fit factory type Hi-Po exhaust manifolds  
\*\*Requires use of 66+ Frame Brackets ††68-69 Only

### OLDSMOBILE

Cutlass	73-76	250 6 cyl.	7-506	7-1604	7-1906
Cutlass	78-87	260-350	7-506	7-1604	7-1906
Custom Cruiser	81-82	267 8 cyl.	7-506	N/A	N/A
Custom Cruiser	91-92	305 8 cyl.	7-506	7-1604	7-1906
Custom Cruiser	92	350 8 cyl.	7-506	N/A	N/A
Delta 88	77	350 8 cyl.	7-506	7-1604	7-1906
Delta 88	81-82	267 8 cyl.	7-506	N/A	N/A
Omega/Starfire	77-79	305/350	7-506	7-1604	7-1906

### PONTIAC

Astre	79	305 8 cyl.	7-506	N/A	N/A
Bonneville	78-80	267/305	7-506	7-1604	7-1906
Catalina	81	267 8 cyl.	7-506	7-1604	7-1906
Catalina	78-81	305 8 cyl.	7-506	7-1604	7-1906
Firebird	73-76	250 6 cyl.	7-506	7-1604	7-1906
Firebird	80-81	265 8 cyl.	7-506	7-1604	7-1906
Firebird	77-92	267-350	7-506	7-1604	7-1906
Firebird	93-97	350 8 cyl.	7-508	7-1604	7-1909
Firebird	98-02	350 LS1	7-512	7-1604	7-1908
Firebird	93-95	3.4 Ltr. 6 cyl.	N/A	7-1604	N/A
Firebird	96-00	3.8 Ltr. 6 cyl.	N/A	7-1604	N/A
Grand Prix	76-87	305/350	7-506	7-1604	7-1906
Grand Prix	74-76	400/455	7-506	7-1604	7-1906
LeMans	73-76	250 6 cyl.	7-506	7-1604	7-1906
LeMans	77-81	305/350	7-506	7-1604	7-1906
Phoenix	78-79	305/350	7-506	N/A	N/A
Ventura	71-77	250-350	7-506	7-1604	7-1906



#6-1905 Motor & Transmission Mount Combo Kit

# Total Kit Charts: Cars

Total Performance from TOTAL KITS™

#6-2036 '97-'03 Ford F150 & 250 Total Kit

Matched components are precisely engineered for a perfect fit to your vehicle's specific model and year.



Our Total Kits are designed to eliminate driveline deflection, resulting in the vehicle better transmitting its horsepower to the ground.

Tough urethane formulation components are used throughout that will last the lifetime of your vehicle.

## Import & Domestic Cars

Make & Model	Year	Kit #	Ball Joint Boots	Body Mounts	Control Arm Front	Control Arm Rear	Drive Train	Shifter Bushings	Shock Bushings	Spring Pds/Coil Iso.	Spring/Shackle Rr.	Strut Bushings	Strut Arm/Rod B.	Sway Tower Bush.	Sway Bar Bushings	Sway Bar End Links	Tie Rod Boots	Trans. Mount
Acura Integra • w/o Rear Upper C-Arm Bushings •	90-93	8-2004	X	X	X	X	X	X			X	X		X	X			
Acura Integra • w/ All C-Arm Bushings •	90-93	8-2011	X	X	X	X	X	X			X	X		X	X			
Acura Integra • w/o Rear Upper C-Arm Bush. •	94-01	8-2005	X	X	X	X	X	X			X	X		X	X			
Acura Integra • w/ All C-Arm Bushings •	94-01	8-2012	X	X	X	X	X	X			X	X		X	X			
Acura RSX (Including Type-S)	02-06	8-2019		X	X									X				
AMC Mid Size	64-69	1-2010		X						°	X			X	X			
AMC Mid Size	70-83	1-2011		X						°	X			X	X			
AMC Full Size	70-83	1-2012		X	X					°		X		X	X			
Buick Century / Skylark	66-72	7-2001	X	X	X											X	X	X
Buick Century / Skylark	74-77	7-2004	X	X	X											X	X	X
Buick Regal / Grand National	78-87	7-2007	X	X	X											X	X	X
Chevrolet Camaro (Multi-Leaf)	67-69	7-2040	X	X	X					X	X					X	X	X
Chevrolet Camaro (Mono-Leaf)	67-69	7-2002	X	X	X					X	X					X	X	X
Chevrolet Camaro	70-72	7-2028	X	X	X					X	X					X	X	X
Chevrolet Camaro	73-74	7-2029	X	X	X					X	X					X	X	X
Chevrolet Camaro	75-79	7-2005	X	X	X					X	X					X	X	X
Chevrolet Camaro	80-81	7-2030	X	X	X					X	X					X	X	X
Chevrolet Camaro	82-92	7-2008	X		X	X					X					X	X	X
Chevrolet Camaro	93-02	7-2009			X	X	X							X	X	X	X	X
Chevrolet Camaro* • w/ Sub-Frame Bushings	10-15	7-2044			X	X	X	X					X	X	X			
Chevrolet Camaro* • w/ Sub-Frame Inserts	10-11	7-2045			X	X	X						X	X	X			
Chevrolet (2 Door Hardtop Only)	65-70	7-2015	X	X	X	X							X	X		X	X	X
Chevrolet Caprice / Impala	80-90	7-2026	X		X	X				°						X	X	X
Chevrolet Caprice / Impala	59-64	7-2032			X	X										X	X	X
Chevrolet Chevelle / Malibu	68-73 E	7-2003	X	X	X	X										X	X	X
Chevrolet Chevelle / Malibu / El Camino / Laguna	73-77	7-2004	X		X	X										X	X	X
Chevrolet Chevelle / Malibu / El Camino	78-88	7-2007	X		X	X					X					X	X	X
Chevrolet Cobalt	05-10	7-2049			X	X								X				
Chevrolet Cobalt SS	04-10	7-2049			X	X								X				
Chevrolet Corvette	63-82	7-2012	X		X	X	X			X	X					X	X	X
Chevrolet Corvette	84-96	7-2013			X	X	X			X	X					X		
Chevrolet Corvette	97-13	7-2014			X	X	X			X	X					X		
Chevrolet HHR	06-11	7-2049			X	X	X							X				
Chevrolet All Cars • Includes Motor Mounts •	55-57	7-2010		X	X	X					X				X	X	X	X
Chevrolet Impala Convertible	65-70	7-2048		X	X	X							X		X	X	X	X
Chevrolet Monte Carlo	78-88	7-2007	X		X	X									X	X	X	X
Chevrolet Nova	62-67	7-2011	X		X					X	X				X	X	X	X
Chevrolet Nova (Multi-Leaf)	68-74	7-2040	X	X	X					X	X				X	X	X	X
Chevrolet Nova (Mono-Leaf)	68-74	7-2002	X	X	X					X	X				X	X	X	X
Chevrolet Nova	75-79	7-2027	X		X					X					X	X	X	X

(\*) Includes RR Toe & TA Link Bushings Kit (°) Coil Isolators

## Import & Domestic Cars

Make & Model	Year	Kit #	Ball Joint Boots	Body Mounts	Control Arm Front	Control Arm Rear	Drive Train	Shifter Bushings	Shock Bushings	Spig Pds/Coil Iso.	Spring/Shackle Rt.	Steering Bushings	Strut Arm/Rod B.	Strut Lower Bush.	Sway Bar Bushings	Tie Rod End Links	Trans. Mount
Chrysler PT Cruiser (Including Touring Edition)	01-06	4-2006		X					°					X	X		
Chrysler 300C	05-10	4-2010	°°	X	X	X					X			X	X		
Dodge & Plymouth "A", "B" & "E" Bodies	62-76	4-2001		X						X		X			X	X	
Dodge Neon (Including Sport Package)	95-99	4-2002		X	X							X		X	X	X	
Dodge Neon / SRT-4	00-06	4-2007		X								X		X	X	X	
Dodge Challenger	05-10	4-2010	°°	X	X	X				X		X		X	X	X	
Dodge Charger	05-10	4-2010	°°	X	X	X				X		X		X	X	X	
Dodge Magnum	05-08	4-2010	°°	X	X	X				X		X		X	X	X	
Ford Focus / SVT	00-06	6-2026		X	X				°					X	X		
Ford Mustang • w/o Trans. Mount •	65-66	6-2004		X						X		X			X	X	
Ford Mustang • w/ Trans. Mount •	65-66	6-2024		X						X		X			X	X	X
Ford Mustang • w/o Trans. Mount •	67-73	6-2001		X						X		X			X	X	X
Ford Mustang • w/o Trans. Mount •	79-82	6-2029		X	X	X			°			X			X	X	X
Ford Mustang V8 • w/ Trans. Mount* •	79-82	6-2030		X	X	X			°			X			X	X	X
Ford Mustang • w/o Trans. Mount •	83-84	6-2031		X	X	X			°			X		X	X	X	X
Ford Mustang V8 • w/ Trans. Mount* •	83-84	6-2032		X	X	X			°			X	X	X	X	X	X
Ford Mustang • w/o Trans. Mount •	85-93	6-2002		X	X	X				X		X		X	X	X	X
Ford Mustang V8 • w/ Trans Mount •	85-93	6-2005		X	X	X			X	X		X		X	X	X	X
Ford Mustang • w/o Trans. Mount •	94-98	6-2003		X	X	X			X	X		X		X	X	X	X
Ford Mustang V8 • w/ Trans Mount ** •	94-98	6-2006		X	X	X			X	X		X		X	X	X	X
Ford Mustang (Except Cobra)	99-04	6-2025		X	X	X			°	X		X		X	X	X	X
Ford Mustang Cobra	99-04	6-2033	X	X	X				°	X	X	X		X	X	X	X
Ford Mustang GT	05-06	6-2034		X	X		X							X	X		

(\*) 6 cyl. With Automatic Transmission (\*\*) Does not fit 96-98 GT With Manual Transmission (°) Coil Isolators (°°) Sub Frame Bushings



#7-2044 Camaro '10-'14 Total Kit



#6-2005 Mustang '85-'93 Total Kit



#4-2010-BL 300C, Challenger, Charger & Magnum Total Kit



#6-2006 Mustang '94-'98 w/Trans Mount

## Import & Domestic Cars

Make & Model	Year	Kit #	Bell Joint Boots	Body Mounts	Control Arm Front	Control Arm Rear	Drive Train	Shifter Bushings	Shock Bushings	Sparg. Pds./Coil Iso.	Spring/Shackle Rt.	Sleeving Bushings	Strut Arm/Rod B.	Strut Tower Bush.	Sway Bar Bush.	Sway Bar End Bushings	Tie Rod Links	Trans. Mount
Honda Accord • w/o Rear Upper C-Arm Bushings •	90-93	8-2006	X		X	X			X			X		X	X	X	X	
Honda Accord • w/ All Control Arm Bushings •	90-93	8-2013	X		X	X			X			X		X	X	X	X	
Honda Accord • w/o Rear Upper C-Arm Bushings •	94-97	8-2007	X		X	X			X			X		X	X	X	X	
Honda Accord • w/ All Control Arm Bushings •	94-97	8-2014	X		X	X			X			X		X	X	X	X	
Honda Civic	84-87	8-2001	X		X	X		X						X	X	X	X	
Honda Civic • w/o Rear Upper Control Arm Bushings •	88-91	8-2002	X		X	X		X	X		X			X	X	X	X	
Honda Civic • w/ All Control Arm Bushings •	88-91	8-2009	X		X	X		X	X		X			X	X	X	X	
Honda Civic • w/o Rear Upper Control Arm Bushings •	92-95	8-2003	X		X	X		X	X		X			X	X	X	X	
Honda Civic • w/ All Control Arm Bushings •	92-95	8-2010	X		X	X		X	X		X			X	X	X	X	
Honda Civic • w/o Upper Control Arm Bushings •	96-00	8-2017	X		X	X		X	X					X	X	X	X	
Honda Civic • w/ All Control Arm Bushings •	96-00	8-2008	X		X	X		X	X					X	X	X	X	
Honda Civic Si • w/ Upper Control Arm Bushings •	99-00	8-2015	X		X	X		X	X					X	X	X	X	
Honda Civic Si • w/o Upper Control Arm Bushings •	99-00	8-2016	X		X	X		X	X					X	X	X	X	
Honda Civic/Civic Si	01-05	8-2019			X	X								X	X	X	X	
Honda Civic • w/ Front & Rear Sway Bar Bush. •	06-11	8-2020			X	X								X	X	X	X	
Honda Prelude	92-96	8-2018	X		X	X		X			X			X	X	X	X	
Honda S2000	99-09	8-2022			X	X	X		X					X	X	X	X	
Infiniti G35 • w/ Front & Rear Sway Bar Bush. •	03-07	14-2007		°°	X	X	X				X			X	X	X	X	
Mazda RX-7	86-91	12-2001	X		X	X								X	X	X	X	
Mercury Capri • w/o Trans. Mount •	79-86	6-2002			X	X	X		°		X		X	X	X	X	X	
Mercury Capri • w/ Trans. Mount •	79-86	6-2005			X	X	X		°		X		X	X	X	X	X	X
Mitsubishi Eclipse, FWD & AWD	95-99	13-2001			X	X		X						X	X	X	X	
Mitsubishi Eclipse	00-05	13-2002			X	X								X	X	X	X	
Mitsubishi EVO 8 • w/ Front & Rear Sway Bar Bush. •	03-06	13-2003			X	X	X							X	X	X	X	
Nissan 240SX	89-94	14-2005		°°	X	X					X	X		X	X	X	X	
Nissan 240SX	95-98	14-2006			X	X					X	X		X	X	X	X	
Nissan/Datsun 240Z	70-73	14-2001			X	X	X				X	X		X	X	X	X	
Nissan/Datsun 260/280Z	74-78	14-2002			X	X	X				X	X		X	X	X	X	
Nissan/Datsun 280ZX	79-83	14-2003			X	X	X				X	X		X	X	X	X	
Nissan 300ZX	84-89	14-2004			X	X	X				X	X		X	X	X	X	
Nissan 350Z • w/ Front & Rear Sway Bar Bush. •	03-09	14-2007		°°	X	X	X				X			X	X	X	X	

(°) Coil Isolators (°°) Sub Frame Bushings



#8-2020 Honda Civic '06-'11 Total Kit



#14-2007-BL Nissan 350Z & Infiniti G35 Total Kit



#13-2001 Mitsubishi Eclipse, FWD & AWD Total Kit



#13-2003 Mitsubishi EVO 8 Total Kit

## Import & Domestic Cars

Make & Model	Year	Kit #	Ball Joint Boots	Body Mounts	Control Arm Front	Control Arm Rear	Drive Train	Shifter Bushings	Shock Bushings	Spig Pds/Coil Iso.	Spring/Shackle Rr.	Steering Bushings	Strut Arm/Rod B.	Strut Tower Bush.	Sway Bar Bushings	Sway Bar End Links	Tie Rod Boots	Trans. Mount
Oldsmobile Cutlass/442	66-72	7-2001	X	X	X										X	X	X	
Oldsmobile Cutlass/442	74-77	7-2004	X	X	X										X	X	X	
Oldsmobile Cutlass/442	78-87	7-2007	X	X	X										X	X	X	
Pontiac Fiero	84-87	7-2034	X	X	X										X	X	X	
Pontiac Firebird	67-69	7-2002	X	X	X			X	X						X	X	X	
Pontiac Firebird	70-72	7-2028	X	X	X			X	X						X	X	X	
Pontiac Firebird	73	7-2029	X	X	X			X	X						X	X	X	
Pontiac Firebird	74-75	7-2005	X	X	X			X	X						X	X	X	
Pontiac Firebird	76-79	7-2006	X	X	X			X	X						X	X	X	
Pontiac Firebird	80-81	7-2031	X	X	X			X	X						X	X	X	
Pontiac Firebird	82-92	7-2008		X	X							X	X		X	X	X	
Pontiac Firebird	93-02	7-2009		X	X	X							X		X	X	X	X
Pontiac Grand AM	78-81	7-2007	X	X	X										X	X	X	
Pontiac Grand Prix	82-87	7-2007	X	X	X										X	X	X	
Pontiac GTO	04-06	7-2041		X	X								X	X	X	X	X	
Pontiac LeMans/GTO	66	7-2037	X	X	X										X	X	X	X
Pontiac LeMans/GTO	67-72	7-2038	X	X	X										X	X	X	X
Pontiac LeMans/GTO	74-77	7-2004	X	X	X										X	X	X	
Subaru WRX Impreza • w/ Frt. & Rr. Sway Bar Bush.	98-05	16-2001		X	X		X								X			
Subaru Legacy	04-09	16-2004		X	X						X							
Subaru STI	08-10	16-2003		X	X	X	X				X							
Subaru WRX	08-10	16-2002		X	X	X	X				X							
Toyota Celica	00-05	18-2007		X	X										X			
Toyota Corolla GTS/SR5 (Rear Wheel Drive)	85-87	18-2010		X	X							X	X		X	X		
Toyota MR2	85-89	18-2008		X	X						X		X		X			
Toyota MR2	91-95	18-2009		X	X							X			X			
Volkswagen Rabbit/Golf/Jetta	75-84	22-2008		X	X	X		X			X	X						
Volkswagen Golf II/Jetta II	85-98	22-2009		X	X			X			X	X						

(\*) Sub Frame Insert Bushings



#7-2006-BL Pontiac Firebird '76-'79 Total Kit



#16-2003 Subaru STI '08-'10 Total Kit



#18-2009 Toyota MR2 Total Kit



#22-2009 VW Golf II/ Jetta II Total Kit

## Domestic Trucks

Make & Model	Year	Kit #	Axle Pivot Bush.	Body Mounts	"C" Bushings	Control Arm Front	Control Arm Rear	Front Diff. Mount	Spring/Shackle Fr.	Spring/Shackle Rr.	Shut Arm/Rod B.	Sway Bar Bushings	Tie Rod End Links	Torque Arms	Track Arm Bush	Track Arm-Front	Track Arm-Rear	Trans. Mount
Chevrolet/GMC Full Size 2WD	63-66	7-2023	X			X										X	X	
Chevrolet/GMC Full Size 2WD	67-72	7-2024	X									X				X	X	
Chevrolet/GMC Full Size 2WD	73-80	7-2016	X		X				X			X				X	X	
Chevrolet/GMC Full Size 2WD	81-87	7-2018	X		X				X			X				X	X	
Chevrolet/GMC Full Size 2WD	88-98	7-2021	X		X				X			X	X			X	X	
Chevrolet/GMC Full Size 2WD 1500 (All Cabs)	99-06	7-2042	X		X				X			X						
Chevrolet/GMC Full Size 2WD 2500HD (All Cabs)	01-06	7-2043	X		X				X			X						
Chevrolet/GMC Full Size 4WD	73-80	7-2017	X					X	X				X				X	
Chevrolet/GMC Full Size 4WD	81-87	7-2019	X					X	X			X	X					
Chevrolet/GMC Full Size 4WD (Std. & Xtra Cab)	88-98	7-2022	X		X				X			X	X					
Chevrolet/GMC Full Size 4WD 2500HD (All Cabs)	01-06	7-2043	X		X				X			X	X					
Chevrolet/GMC S10 Pickup 2WD STD. Cab	82-04	7-2020	X		X				X			X	X					
Chevrolet/GMC S10 Pickup 2WD Xtra Cab	82-04	7-2039	X		X				X			X	X					
Chevrolet/GMC S10 Pickup 4WD STD. Cab	83-04	7-2033	X		X				X			X	X	X				
Chevrolet Suburban 1/2 Ton	81-87	7-2025	X		X				X			X	X				X	
Chevrolet/GMC Blazer 4WD	92-94	7-2035	X		X				X			X	X					
Chevrolet/GMC Tahoe/Yukon 2WD	96-99	7-2036	X		X				X			X	X					X
Chevrolet Silverado & GMC Sierra Crew Cab 2WD	07-14	7-2046	X		X				X			X						
Chevrolet Silverado & GMC Sierra Crew Cab 4WD	07-14	7-2047	X		X		X		X			X						
Dodge Full Size 4WD	72-85	4-2016	X					X	X				X					
Dodge Ram Charger 4WD	72-93	4-2017	X					X	X				X					
Dodge Dakota 2WD	87-96	4-2003	X		X				X			X	X					
Dodge Ram 2WD	94-01	4-2004	X		X				X			X	X					
Dodge Ram 4WD	94-01	4-2005	X		X				X			X	X					
Dodge Ram 2500 & 3500 4WD Diesel & V-10	94-01	4-2008	X		X				X			X			X			



#4-2008-BL Dodge Ram 2500 & 3500 4WD Diesel & V-10 '94-'01 Total Kit



#4-2005 Dodge Ram 4WD Total Kit



#7-2042 Chevy & GMC 2WD 1500 '99-'06 Total Kit



#7-2046 Chevy & GMC Crew Cab, Full Size 2WD '11-'14 Total Kit



## Domestic & Import SUVs & Trucks

Make & Model	Year	Kit #	Axle Pivot Bush.	Body Mounts	"C" Bushings	Control Arm	Control Arm Front	Control Arm Rear	Spring Pads	Spring/Shackle Fr.	Strut Arm/Rod B.	Sway Bar Bushings	Sway Bar End Links	Tie Rod Boots	Torque Arm Bush.	Track Arm-Front	Track Arm-Rear	Trans. Mount
Ford Bronco I	66-77	6-2016		X						X	X							
Ford Bronco II 4WD	84-88	6-2023	X	X						X	X							
Ford Full Size Truck 2WD F100, F150	66-79	6-2020	X	X						X	X							
Ford Full Size Truck 2WD F150	87-96	6-2028	X	X						X	X							
Ford Full Size Truck 2WD F150 (All Cabs)	97-03	6-2035		X						X		X						
Ford Full Size Truck 2WD & 4WD F150	04-06	6-2038			X					X		X						
Ford Full Size Truck 4WD F150	73-79	6-2017		X						X	X					X		
Ford Full Size Truck 4WD F150	80-96	6-2018	X	X					X	X								
Ford Full Size Truck 4WD F150/F250LD (All Cabs)	97-03	6-2036		X						X		X						
Ford Full Size Truck 4WD F250	80-98	6-2027	X	X					X	X			X					
Ford Full Size Truck 4WD F250	99-04	6-2037							X	X	X					X		
Ford Explorer 4WD	91-94	6-2019	X							X	X	X	X	X				
Ford Ranger 2WD Std. & Xtra Cab	83-97	6-2021	X	X						X	X							
Ford Ranger 4WD Std. & Xtra Cab	83-97	6-2022	X	X						X	X							
Ford Van E250 2WD & E350 2WD	92-06	6-2039	X							X	X	X	X	X				
Honda CR-V ††	97-01	8-2021			X	X												
Jeep CJ5/CJ7	55-73	1-2001		X					X	X				X				
Jeep CJ5/CJ7 • w/Trans. Mount •	74-75	1-2013		X					X	X				X				X
Jeep CJ5/CJ7 (w/Trans. Mount, order #1-2007)	76-79	1-2002		X					X	X			X	X	X			
Jeep CJ5/CJ7 (w/Trans. Mount, order #1-2008)	80-86	1-2003		X					X	X			X	X	X			
Jeep CJ8 Scrambler • w/Trans. Mount •	81-86	1-2014		X					X	X			X	X	X			X
Jeep Cherokee	84-01	1-2004			X					X				X				
Jeep Grand Cherokee	93-98	1-2016			X	X				X	X	X	X	X		X	X	
Jeep Wrangler JK 4DR*	07-14	1-2017		X	X	X				X	X	X	X	X		X	X	
Jeep Wrangler JK 2DR*	07-14	1-2018		X	X	X				X	X	X	X	X		X	X	
Jeep Wrangler YJ (w/Trans. Mount, order #1-2009)	87-96	1-2005		X					X	X				X				
Jeep Wrangler TJ	97-06	1-2006		X		X	X	X						X				
Subaru Outback (1)	04-09	16-2004				X												
Subaru Forester **	09-10	16-2005	°°	X														
Toyota 2WD	79-83	18-2001				X				X	X	X	X	X				
Toyota 2WD	84-88	18-2002				X				X	X	X	X	X				
Toyota 2WD	89-94	18-2004				X				X	X	X	X	X				
Toyota 4WD	79-85	18-2016		X					X	X	X	X	X	X				
Toyota 4WD	86-88	18-2003		X		X				X	X	X	X	X				
Toyota 4WD	89-94	18-2005		X		X				X	X	X	X	X				
Toyota 4Runner 4WD	84-88	18-2006		X		X			X	X				X				

(1) Total Kit For Subaru Includes: Rear Diff. Frt. Mt. Bushing Kit, Front Control Arm Bushings & Steering Rack Bushings (\*) Includes Bump Stops (\*\*) Total Kit For Subaru Also Includes: Shifter Bushings, Steering Rack Bushings, Rear Differential Bushings and- (°°) Sub Frame Insert Bushings (††) Includes: Ball Joint Boots, Compensator Arm Bushings, Shock Bushings, Tie Rod Boots



#8-2021 Honda CR-V ††



#18-2004-Toyota 2WD Total Kit



#1-2017-BL Jeep® Wrangler JK 2DR '07-'14 Total Kit



#6-2038 Ford F150 2WD & 4WD '04-'06 Total Kit

## ACURA

### BALL JOINT BOOTS

<b>(Integra)</b>		
86-89	Front Ball Joint Boot Kit (2)	19-1712
90-01	Front Ball Joint Boot Kit (4)	8-1701

### CONTROL ARM BUSHINGS, Front

<b>(Integra,RSX Including Type-S)</b>		
86-89	Control Arm Bushing Kit, Lower	8-201
90-93	Upper Control Arm Bushing Kit	8-217
90-93	Lower Control Arm Bushing Kit	8-210
90-93	Control Arm Bushing Kit, Upper & Lower	8-206
94-01	Upper Control Arm Bushing Kit	8-211
94-01	Lower Control Arm Bushing Kit	8-212
94-01	Control Arm Bushing Kit, Upper & Lower	8-203
02-06	Lower Control Arm Bushing Kit	8-215
<b>(NSX)</b>		
91-05	Upper Control Arm Bushing Kit	8-225
<b>(RDX)</b>		
07-12	Front Control Arm Bushing Kit	8-226
<b>(CL)</b>		
01-03	Lower Control Arm Bushing Kit	8-227
<b>(TL)</b>		
99-03	Lower Control Arm Bushing Kit	8-227

### CONTROL ARM BUSHINGS, Rear

<b>(Integra,RSX Including Type-S)</b>		
90-01	Lower Control Arm Bushing Kit	8-303
90-01	Compensator Arm Bushing Kit	8-309
90-01	Control Arm Bushing Kit, Upper & Lower	8-310
97-01	Upper Control Arm Bushing Kit (Type-R)	8-307
97-01	Lower Control Arm Bushing Kit (Type-R)	8-317
02-06	Control Arm Bushing Kit, Upper & Lower	8-318
<b>(NSX)</b>		
91-05	Control Arm Bushing Kit	8-323
<b>(RDX)</b>		
07-12	Rear Control Arm Bushing Kit	8-324

### CONTROL ARMS, Rear

<b>(Integra)</b>		
90-01	Upper Control Arms with Bushings, Billet Aluminum with PROTHANE logo	8-321

### COMPENSATOR ARMS

<b>(Integra)</b>		
90-01	Compensator Arms (with Bushings, Billet Aluminum with PROTHANE logo)	8-322

### MOTOR MOUNT INSERTS

<b>(Integra)</b>		
90-91	Engine Mount Insert Kit, Left Upper (GS, LS, RS)	8-510
92-93	Engine Mount Insert Kit, Left Upper (GS, LS, RS)	8-516
92-93	Engine Mount Insert Kit, Left Upper (GSR)	8-510
90-93	Trans. Mount Insert Kit, Right Upper	8-511
90-93	Fire wall Mount Insert Kit, Rear	8-512
90-91	All 3 Mounts Kit (GS, LS, RS)	8-1905
92-93	All 3 Mounts Kit (GS, LS, RS)	8-1908
92-93	All 3 Mounts Kit (GSR)	8-1905
94-01	Engine Mount Insert Kit, Left Upper	8-501
94-01	Trans. Mount Insert Kit, Right Upper	8-502
94-01	Fire wall Mount Insert Kit, Rear	8-509
94-01	All 3 Mounts Kit	8-1904
<b>(RDX)</b>		
07-12	Motor Mount Kit	8-519



#8-2011 Acura Integra '90-'93 Total Kit

### REAR TRAILING ARM BUSHINGS

<b>(Integra)</b>		
90-93	Rear Trailing Arm Bushing Kit	8-314
94-01	Rear Trailing Arm Bushing Kit	8-304

### SHIFTER STABILIZER BUSHINGS

<b>(Integra)</b>		
90-01	Shifter Stabilizer Bushing Kit	8-1601

### SHOCK BUSHINGS

<b>(Integra)</b>		
90-01	Front Shock Bushing Kit	8-901
90-01	Rear Shock Bushing Kit	8-902

### STEERING

<b>(Integra)</b>		
90-93	Rack & Pinion Bushing Kit, Power Ster. Only	8-703
94-01	Rack & Pinion Bushing Kit, Power Ster. Only	8-702

### STRUT ROD BUSHINGS

<b>(Integra)</b>		
90-93	Front Strut Rod Bushing Kit	8-1203

### SUB-FRAME BUSHINGS KIT

<b>(RDX)</b>		
07-12	Sub-frame Bushing Kit	8-100

### SWAY BAR & END LINK BUSHINGS, Front

<b>(Integra, RSX Including Type-S)</b>		
86-89	Sway Bar Bushing & End Link Kit, 16mm Bar	8-1103
90-93	Sway Bar Bushing Kit, 22mm Bar	8-1118
90-93	Sway Bar Bushing Kit, 23mm Bar	8-1117
94-01	Sway Bar Bushing & End Link Kit, 21mm Bar	8-1101
94-01	Sway Bar Bushing Kit, 21mm Bar	8-1121
94-01	Sway Bar Bushing Kit, 22mm Bar	8-1109
94-01	Sway Bar Bushing Kit, 24mm Bar	8-1110
02-06	Sway Bar Bushing Kit, 23mm Bar	8-1135
90-01	Sway Bar End Link Kit	8-401

### SWAY BAR BUSHINGS, Rear

<b>(Integra, RDX, RSX Including Type-S)</b>		
90-93	Sway Bar Bushing Kit, 16mm Bar	8-1119
94-01	Sway Bar Bushing Kit, 13mm Bar	8-1111
94-01	Sway Bar Bushing Kit, 14mm Bar	8-1116
02-06	Sway Bar Bushing Kit, 19mm Bar	8-1136

### SWAY BAR BUSHINGS, Front & Rear

<b>(NSX)</b>		
90-91	Sway Bar Bushing Kit	8-1146

### TIE ROD BOOTS

<b>(Integra)</b>		
86-01	Tie Rod Boot Kit (2)	19-1711

### TOTAL KITS

<b>(Integra, RDX, RSX Including Type-S)</b>		
90-93	Total Kit, w/o Rear Upper C-Arm Bushings *†	8-2004
90-93	Total Kit, w/ Rear Upper C-Arm Bushings *†	8-2011
94-01	Total Kit, w/o Rear Upper C-Arm Bushings *†	8-2005
94-01	Total Kit, w/ Rear Upper C-Arm Bushings *†	8-2012
02-06	Total Kit *	8-2019
<b>(RDX)</b>		
07-12	Total Kit *	8-2023

(\* Total Kits do not contain the Rear Trailing Arm Bushing)  
 († Does not include Sway Bar Bushing)



#8-2019-BL Acura RSX '02-'06 Total Kit

# AMC

## BUMP STOPS

(All Models)

70-83	Front Upper Control Arm Bump Stops	19-1312
-------	------------------------------------	---------

## COIL SPRING ISOLATORS, Front

(All Models)

64-69	Front Coil Spring Isolator Kit (4)	1-1706
70-83	Front Upper Spring Isolator Kit (2)	1-1704

## CONTROL ARM BUSHINGS, Front

(Ambassador, Classic, Marlin, Matador, Rebel)

67-69	Front Control Arm Bushing Kit, w/o Shells	1-206
-------	---	-------

70-78	Front Control Arm Bushing Kit, w/o Shells	1-207
-------	---	-------

(American, AMX, Concord, Gremlin, Hornet, Javelin, Rambler, Rogue, Spirit)

64-69	Front Control Arm Bushing Kit, w/o Shells	1-206
-------	---	-------

64-69	Front Trunion Bushing Only Kit	1-209
-------	--------------------------------	-------

64-69	Front Trunion w/Pivot Bushing Kit	1-210
-------	-----------------------------------	-------

70-83	Front Control Arm Bushing Kit, w/o Shells	1-207
-------	---	-------

(Eagle, SX-4)

80-88	Front Upper Control Arm Bushing Kit, w/o Shells	1-208
-------	---	-------

## CONTROL ARM BUSHINGS, Rear

(Ambassador, Classic, Marlin, Matador, Rebel)

67-78	Rear Control Arm Bushing Kit, w/ Shells	7-225
-------	---	-------

## DRIVE TRAIN

(AMX)

68-70	Torque Link Kit	1-1602
-------	-----------------	--------

## MOTOR MOUNTS

(All Models)

64-83	Motor Mount Kit, Pair (6 Cyl.)	1-501
-------	--------------------------------	-------

67-83	Motor Mount Kit, Pair (8 Cyl.)	1-503
-------	--------------------------------	-------

## SHOCK BUSHINGS

(All Models)

70-83	Front Shock Bushings (Stem Type, 4 Pcs.)	19-901
-------	--	--------

## SPRING & SHACKLE BUSHINGS, Rear

(American, AMX, Concord, Gremlin, Hornet, Javelin, Rambler, Rogue, Spirit)

64-69	Rear Heavy Duty Shackle & Bushing Kit	1-811
-------	---------------------------------------	-------

64-69	Spring Eye & Shackle Bushing Kit (w/ 1.5" OD Front Spring Eye)	1-1009
-------	--	--------

64-69	Spring Eye & Heavy Duty Shackle Kit	1-1011
-------	-------------------------------------	--------

70-74	Sprg. Eye & Shackle Bushing Kit (AMX, Javelin)	1-1010
-------	--	--------

70-74	Sprg. Eye & Heavy Duty Shackle Kit (AMX, Javelin)	1-1013
-------	---	--------

70-74	Rear Heavy Duty Shackle & Bushing Kit (AMX, Javelin)	1-813
-------	--	-------

70-83	Spring Eye & Heavy Duty Shackle Kit (Except AMX, Javelin)	1-1012
-------	---	--------

70-83	Rear Heavy Duty Shackle Kit Only (Except AMX, Javelin)	1-812
-------	--	-------

70-83	Spring Eye & Shackle Bushing Kit (w/ 2.0" OD Front Spring Eye)	1-1008
-------	--	--------

(Spring Kits Listed Above Will Only Fit 2.5" Wide Springs)

(Pacer, Eagle, SX-4)

75-88	Spring Eye & Shackle Bushing Kit (w/ 1.5" OD Front Spring Eye)	1-1009
-------	--	--------



#1-811 Rear Heavy Duty Shackle & Bushing Kit

## STRUT ROD BUSHINGS

(Ambassador, Classic, Marlin, Matador, Rebel)

62-64	Front Strut Rod Bushing Kit, 5/8"	1-1207
-------	-----------------------------------	--------

70-78	Front Strut Rod Bushing Kit (2 Piece Design)	6-1205
-------	--	--------

(American, AMX, Concord, Gremlin, Hornet, Javelin, Rambler, Rogue, Spirit)		
--	--	--

64-83	Front Strut Rod Bushing Kit (2 Piece Design)	6-1205
-------	--	--------

(Eagle, SX-4)		
---------------	--	--

80-88	Front Strut Rod Bushing Kit (2 Piece Design)	6-1205
-------	--	--------

## SWAY BAR BUSHINGS, Front

(Ambassador, Classic, Marlin, Matador, Rebel)

64-78	Front Sway Bar Bushing Kit, 13/16" Bar	1-1120
-------	--	--------

64-78	Front Sway Bar Bushing Kit, 7/8" Bar	1-1121
-------	--------------------------------------	--------

(American, AMX, Concord, Gremlin, Hornet, Javelin, Rambler, Rogue, Spirit)

64-83	Front Sway Bar Bushing Kit, 13/16" Bar	1-1120
-------	--	--------

64-83	Front Sway Bar Bushing Kit, 7/8" Bar	1-1121
-------	--------------------------------------	--------

(Pacer, Eagle, SX-4)

75-88	Front Sway Bar Bushing Kit, 7/8" Bar	1-1121
-------	--------------------------------------	--------

## SWAY BAR BUSHINGS, Rear

(Ambassador, Classic, Marlin, Matador, Rebel)

64-78	Rear Sway Bar Bushing Kit, 3/4" Bar	1-1119
-------	-------------------------------------	--------

(American, AMX, Concord, Gremlin, Hornet, Javelin, Rambler, Rogue, Spirit)		
--	--	--

64-83	Rear Sway Bar Bushing Kit, 3/4" Bar	1-1119
-------	-------------------------------------	--------

## SWAY BAR END LINKS, Front / Rear

(Ambassador, Classic, Marlin, Matador, Rebel)

64-78	End Link Kit	19-408
-------	--------------	--------

(American, AMX, Concord, Gremlin, Hornet, Javelin, Rambler, Rogue, Spirit)		
--	--	--

64-83	End Link Kit	19-408
-------	--------------	--------

(Pacer, Eagle, SX-4)

75-88	End Link Kit	19-408
-------	--------------	--------

## TRACK BAR

70-78	Rear Track Bar Bushing Kit	1-1018
-------	----------------------------	--------

(Ambassador)		
--------------	--	--

63-66	Rear Track Bar Bushing Kit	1-1208
-------	----------------------------	--------

## TOTAL KITS

(Ambassador, Classic, Marlin, Matador, Rebel)

70-83	Total Kit	1-2012
-------	-----------	--------

(American, AMX, Concord, Gremlin, Hornet, Javelin, Rambler, Rogue, Spirit)

64-69	Total Kit	1-2010
-------	-----------	--------

70-83	Total Kit	1-2011
-------	-----------	--------



#1-2010-BL AMC AMX, Javelin, etc. '64-'69 Total Kit

## Audi

### MOTOR MOUNT & TRANS MOUNT

(R8)		
All	Motor / Transmission Mount Kit	2-1600

## Austin

### CONTROL ARM BUSHINGS, Front

(Sprite Mark 1 & 2)		
60-67	Control Arm Bushing Kit, Lower Inner	26-45045
60-67	Control Arm Bushing Kit, Upper Outer	26-45054
(Sprite Mark 2A & 3)		
60-67	Control Arm Bushing Kit, Lower Inner	26-45045
60-67	Control Arm Bushing Kit, Upper Outer	26-45054

### SPRING PADS

(100/4, 100/6, 3000)		
54-68	Rear Spring Pad Kit	26-47078
(Sprite Mark 2A & 3)		
60-67	Rear Spring Pad Kit	26-47084

### SPRING & SHACKLE BUSHINGS

(Sprite Mark 2A & 3)		
60-67	Rear Spring, Front Eye Bushing Kit	26-47082
60-67	Rear Spring, Rear Eye & Shackle Bushing Kit	26-47083

### SWAY BAR BUSHINGS

(100/4, 100/6, 3000)		
54-68	Sway Bar Bushing Kit, 14mm Bar	26-42063

## BMW

### CONTROL ARM BUSHINGS, Front

64-76	Control Arm & Strut Arm Bushing Kit (2002)	3-201
-------	--	-------

### CONTROL ARM BUSHINGS, Rear

64-76	Control Arm & Diff. Mount Bushing Kit (2002)	3-202
-------	--	-------

### RADIUS RODS, Front

74-88	Radius Rod Bushing Kit E28 (525, 528, 535, 635)	3-48098
88-95	Radius Rod Bushing Kit E34 (525, 528, 735, 750)	3-48099
84-98	Radius Rod Bushing Kit, E-30 & E36 (3 Series, T1, Z3)	3-48097

### SWAY BAR END LINKS

64-76	Front End Link Bushing Kit (2002)	3-401
64-76	Rear End Link Bushing Kit (2002)	3-401

### SUB FRAME MOUNTS

64-76	Rear Sub Frame Mount Insert Kit (2002)	3-101
66-82	Rear Sub Frame Mount Insert Kit (Bavaria, LS)	3-102
To-82	Rear Sub Frame Mount Insert Kit (3, 5, 6 Series)	3-102

### TIE ROD BOOTS

64-76	Tie Rod Boot Kit (2) (2002)	19-1711
-------	-----------------------------	---------



**#2-1600**  
Audi Transmission /  
Motor Mount Kit

## Buick

### BALL JOINT BOOTS

(Electra, Le Sabre, Centurion, Wildcat)		
85-96	Ball Joint Boot Kit (4)	19-1717
(Century, Regal, Grand National, Skylark thru '72, Special) RWD		
64-72	Ball Joint Boot Kit (4)	19-1715
73-87	Ball Joint Boot Kit (4)	19-1717
(Riviera)		
79-85	Ball Joint Boot Kit (4)	19-1717
(Apollo, Skylark)		
75-79	Ball Joint Boot Kit (4)	19-1717

### BODY MOUNTS

(Century, Regal, Grand National, Special) RWD		
82-87	Body Mount Kit	7-132

### CONTROL ARM BUSHINGS, Front / Rear

(Electra (RWD), Le Sabre (RWD), Centurion, Wildcat)		
71-73	Front Control Arm Bushing Kit, w/Shells	7-212
74-79	Front Control Arm Bushing Kit, w/Shells	7-214
80-94	Front Control Arm Bushing Kit, w/Shells	7-216
65-70	Rear Control Arm Bushing Kit, w/Shells	7-225
(Grand National, Skylark (Thru-'72) Special, Regal (RWD), Century (RWD), except Somerset)		
66-72	Front C-Arm Bushing Kit, w/Shells (w/oval lower)	7-222
66-72	Front C-Arm Bushing Kit, w/Shells (w/round lower)	7-217
73	Front Control Arm Bushing Kit, w/Shells	7-212
74-77	Front Control Arm Bushing Kit, w/Shells	7-214
78-87	Front Control Arm Bushing Kit, w/Shells	7-223
66-87	Rear Control Arm Bushing Kit, w/Shells	7-225
(Riviera)		
71-73	Front Control Arm Bushing Kit, w/Shells	7-212
74-78	Front Control Arm Bushing Kit, w/Shells	7-214
65-70	Rear Control Arm Bushing Kit, w/Shells	7-225
(Somerset)		
87-92	Front Control Arm Bushing Kit, w/o Shells	7-224
(Apollo, Skylark-73 & L)		
73-74	Front Control Arm Bushing Kit, w/Shells	7-217
75-79	Front Control Arm Bushing Kit, w/Shells	7-214
87-96	Front Control Arm Bushing Kit, w/o Shells	7-224

### COIL SPRING ISOLATORS, Rear

(Century, Regal, Grand National, Skylark thru 72, Special) RWD		
67-87	Coil Spring Isolators, Rear Uppers	7-1706
(Electra, LeSabre, Centurion, Wildcat)		
65-84	Coil Spring Isolators, Rear Uppers	7-1706
(Riviera)		
66-78	Coil Spring Isolators, Rear Uppers	7-1706

### MOTOR MOUNTS

Various (See Application Charts on Pages 14-19)

### SWAY BAR BUSHINGS

(Somerset)		
85-87	Rear Sway Bar Bushing Kit, 15mm Bar	7-1156
85-87	Rear Sway Bar Bushing Kit, 17mm Bar	7-1157
85-87	Rear Sway Bar Bushing Kit, 19mm Bar	7-1158

### SWAY BAR END LINKS, Front

(Electra (RWD), Le Sabre (RWD), Centurion, Wildcat)		
65-94	End Link Kit	19-408
(Riviera)		
65	End Link Kit	19-409
66-78	End Link Kit	19-408
(Grand National, Skylark, Special, Regal (RWD), Century (RWD), except Somerset)		
66-72	End Link Kit	19-408
73-77	End Link Kit	19-409
(Apollo, Skylark)		
73-94	End Link Kit	19-408

### TIE ROD BOOTS

All	Tie Rod Boot Kit (2)	19-1712
-----	----------------------	---------

### TRACK ARM BUSHINGS, Rear

(Riviera)		
65-70	Rear Track Arm Bushing Kit (Panhard Bar)	7-1210

### TRANSMISSION MOUNTS

Various (See Application Chart on Page 13)

### TOTAL KITS

66-72	Total Kit (Century, Skylark, Incl. Trans. Mount)	7-2001
74-77	Total Kit (Century, Regal, Incl. Trans. Mount)	7-2004
78-87	Total Kit (Regal, Grand National, Incl. Trans. Mount)	7-2007

## Cadillac

### BALL JOINT BOOTS

(All Except El Dorado & '80-'87 Seville)  
77-94 Ball Joint Boot Kit (4) 19-1717

### BODY MOUNTS

(Escalade)  
00-13 Body Mount Kit (Escalade 2 & 4WD) 7-143  
02-13 Body Mount Kit (Escalade EXT 2 & 4WD) 7-143  
09-13 Body Mount Kit (Escalade Hybrid 2 & 4WD) 7-143

### CONTROL ARM BUSHINGS

(All Except El Dorado & '80-'87 Seville)

79-83 Front Control Arm Bushing Kit, w/Shells 7-216  
77-79 Front Control Arm Bushing Kit, w/Shells 7-214  
(Cimarron)  
87-88 Front Control Arm Bushing Kit, w/o Shells 7-224  
(Escalade)  
02-06 Front Cont. Arm Bushing Kit (Escalade 2WD) 7-236  
02-06 Front Control Arm Bushing Kit (Escalade 4WD, Escalade EXT 4WD) 7-236  
(XLR & XLR-V)  
04-09 Front Control Arm Bushing Kit, w/o Shells 7-232  
04-09 Rear Control Arm Bushing Kit, w/o Shells 7-316

### SWAY BAR BUSHINGS, Front / Rear

(All Except El Dorado & '80-'87 Seville)

77-96 See Universal Product Guide (Pages 8 and 9)  
(Cimarron)  
87-88 Rear Sway Bar Bushing Kit, 15mm Bar 7-1156  
87-88 Rear Sway Bar Bushing Kit, 17mm Bar 7-1157  
87-88 Rear Sway Bar Bushing Kit, 19mm Bar 7-1158  
87-88 Front Sway Bar Bushing Kit, 24mm Bar 7-1159  
87-88 Front Sway Bar Bushing Kit, 26mm Bar 7-1160  
87-88 Front Sway Bar Bushing Kit, 28mm Bar 7-1161  
87-88 Front Sway Bar Bushing Kit, 30mm Bar 7-1162

### SWAY BAR END LINKS

(All)  
77-96 Front Sway Bar End Link Kit 19-408

### TIE ROD BOOTS

(All)  
77-96 Tie Rod Boot Kit (2) 19-1712



#7-1156 Rear Sway Bar Bushing Kit, 15mm Bar



#7-1161 Front Sway Bar Bushing Kit, 28mm Bar

## Chevrolet Beretta, Cavalier, Cobalt, Corsica, Cruze, HHR, Vega, Z-24

### CONTROL ARM BUSHINGS, Front

(Beretta, Corsica)  
87-96 Control Arm Bushing Kit, w/o Shells 7-224  
(Cavalier, Z-24)  
82-86 Control Arm Bushing Kit, w/o Shells 7-233  
87-94 Control Arm Bushing Kit, w/o Shells 7-224  
95-04 Control Arm Bushing Kit, w/o Shells 7-234  
(Cobalt, Cobalt SS, HHR)  
05-10 Control Arm Bushing Kit (Cobalt) 7-244  
04-10 Control Arm Bushing Kit (Cobalt SS) 7-244  
06-11 Control Arm Bushing Kit (HHR) 7-244  
(Vega)  
72-79 Control Arm Bushings 7-280  
(Cruze, Volt)  
11-16 Control Arm Bushing Kit, 7-279  
(Verando)  
12-16 Control Arm Bushing Kit, 7-279

### CONTROL ARM BUSHINGS, Rear

(Cruze)  
11-16 Control Arm Bushing Kit, 7-323  
(Verando)  
12-16 Control Arm Bushing Kit, 7-323

### MOTOR MOUNTS

(Cavalier 5 spd. & Auto. - Non Ecotec)

95-04 Upper Engine Mount Insert 7-513  
95-04 Lower Engine Torque Strut 7-511  
95-04 Trans. Insert Kit (Front Mount, Manual Only) 7-514  
95-04 Trans. Insert Kit (Rear Mount, Manual Only) 7-515  
(Cobalt)  
05-06 Motor Mount Insert Kit, Front or Rear 7-516

### SWAY BAR BUSHINGS, Front

(Beretta, Corsica)  
87-96 Sway Bar Bushing Kit, 24mm Bar 7-1159  
87-96 Sway Bar Bushing Kit, 26mm Bar 7-1160  
87-96 Sway Bar Bushing Kit, 28mm Bar 7-1161  
87-96 Sway Bar Bushing Kit, 30mm Bar 7-1162  
(Cavalier, Z-24)  
82-94 Sway Bar Bushing Kit, 24mm Bar 7-1159  
82-94 Sway Bar Bushing Kit, 26mm Bar 7-1160  
82-94 Sway Bar Bushing Kit, 28mm Bar 7-1161  
82-94 Sway Bar Bushing Kit, 30mm Bar 7-1162  
(Cobalt, Cobalt SS, HHR)  
04-11 Front Sway Bar Bushing Kit, 24mm Bar 7-1190

### SWAY BAR BUSHINGS, Rear

(Beretta, Corsica)  
87-96 Sway Bar Bushing Kit, 15mm Bar 7-1156  
87-96 Sway Bar Bushing Kit, 17mm Bar 7-1157  
87-96 Sway Bar Bushing Kit, 19mm Bar 7-1158  
(Cavalier, Z-24)  
88-94 Sway Bar Bushing Kit, 15mm Bar 7-1156  
88-94 Sway Bar Bushing Kit, 17mm Bar 7-1157  
88-94 Sway Bar Bushing Kit, 19mm Bar 7-1158

### TOTAL KITS

05-10 Total Kit (Cobalt) 7-2049  
04-10 Total Kit (Cobalt SS) 7-2049  
06-11 Total Kit (HHR) 7-2049



#7-234 Cavalier, Z24 '95-'04  
Front Control Arm Bushing Kit

## Chevrolet Camaro

### BALL JOINT BOOTS

67-69	Front Ball Joint Boot Kit (4)	19-1715
70-81	Front Ball Joint Boot Kit (4)	19-1717

### BODY MOUNTS

67-69	Body Mount Kit (Convertible Only, w/Hrdwr.)	7-120
67-81	Body Mount Kit (Hardtop Only w/o Hrdwr.)	7-119
67-81	Body Mount Kit, (Hardtop Only w/ Hrdwr.)	7-139
67-81	Body Mount Hardware Kit, (For 7-119)	7-140

### BUMP STOPS

67-69	Front Lower Cont. Arm Bump Stops (2)	7-1301
70-81	Front Lower Cont. Arm Bump Stops (2)	7-1302

### CONTROL ARM BUSHINGS, Front

67-69	Control Arm Bushing Kit, w/Shells	7-217
70-72	Control Arm Bushing Kit, w/Shells	7-218
73-74	Control Arm Bushing Kit, w/Shells (w/ 1.625" OD Front Lower Bushing)	7-212
73-74	Control Arm Bushing Kit, w/Shells (w/ 1.375" OD Front Lower Bushing)	7-213
75-79	Control Arm Bushing Kit, w/Shells (w/ 1.625" OD Front Lower Bushing)	7-214
80-81	Control Arm Bushing Kit, w/Shells	7-219
82-92	Control Arm Bushing Kit, w/Shells (Lower Only)	7-220
93-02	Control Arm Bushing Kit, w/o Shells	7-227
10-15	Cont. Arm & Trailing Arm Bushing Kit, w/o Shells	7-238

### CONTROL ARM BUSHINGS, Rear

82-02	Control Arm Bushing Kit, w/Shells	7-226
10-15	Control Arm Bushing Kit, w/o Shells	7-319

### DRIVE TRAIN

84-92	Differential To Transmission Torque Arm Kit (See Diagram On This Page)	7-1611
84-02	Differential To Trans. Torque Arm Kit (84-92 Varies) (See Diagram On This Page)	7-1609
10-15	Differential Carrier Bushing Kit	7-1613
82-02	Panhard Rod Bushing Kit	7-2101
82-92	Secondary Trans. Crossmember Kit	7-1605

### LINK BUSHINGS, Rear

10-15	Toe & Trailing Arm Link Bushing Kit	7-1214
-------	-------------------------------------	--------



#7-2040-BL Camaro '67-'69 Total Kit

### MOTOR MOUNTS

Various (See Application Chart on Page 14-19)

### RACK & PINION BUSHINGS

10-15	Rack & Pinion Bushing Kit	7-703
-------	---------------------------	-------

### RADIATOR ISOLATORS

68-87	Radiator Isolators, Small Block Equip. (4 pcs)	7-1711
68-87	Radiator Isolators, Big Block Equip. (4 pcs)	7-1712

### RADIUS ARM BUSHINGS, Front

10-15	Radius Arm Bushing Kit (Front Forward)	7-239
-------	--	-------

### SPRING & SHACKLE, OEM & HD, Rear

67-69	Spring Eye & Shackle Bushing Kit (Mono Leaf)	7-1010
67-69	Spring Eye & Shackle Bushing Kit (Multi Leaf)	7-1011
70-81	Spring Eye & Shackle Bushing Kit (Multi Leaf)	7-1012
67-81	Spring Eye & HD Shackle Kit (Multi Leaf)**+	7-1050
67-81	Rear HD Shackle Kit Only (Multi Leaf)*+	7-1051
67-69	Rear Spring Eye & HD Shackle Kit (Mono Leaf)**	7-1052
67-69	Rear HD Shackle Kit Only (Mono Leaf)*	7-1053

(\*Includes rear only eye bushings, shackle bushings, zinc plated heavy duty steel shackles, bolts and locknuts.)

\*\*Includes both spring eye bushings, shackle bushings, zinc plated heavy duty steel shackles, bolts and locknuts.)  
(+Also fits replacement mono leaf 2.5" wide)

### SPRING PADS, Rear

68-69	Spring Pad Kit, Upper or Lower (Multi Leaf) (2)	7-1701
68-69	Spring Pad Kit, Upper & Lower (Multi Leaf)	7-1708
70-81	Spring Pad Kit, Lower (Multi Leaf)	7-1702
70-81	Spring Pad Kit, Upper (Multi Leaf)	7-1703
70-81	Spring Pad Kit, Upper & Lower (Multi Leaf)	7-1709
67-69	Spring Pad Kit, Upper (Mono Leaf)	7-1704
67-69	Spring Pad Kit, Lower (Mono Leaf)	7-1705
67-69	Spring Pad Kit, Upper & Lower (Mono Leaf)	7-1707



#7-1609 Camaro '84-02  
Differential To Transmission  
Torque Arm Kit

### Differential To Transmission Torque Arm Bushing Kit, As Viewed From Rear Of Transmission-

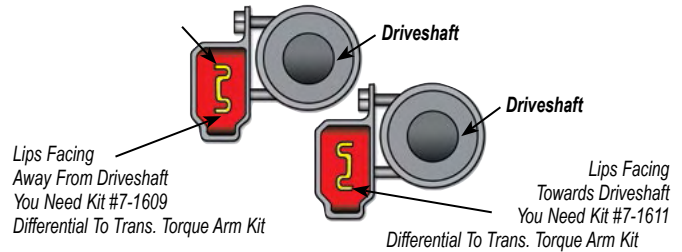

#7-226 Camaro '82-'02  
Rear Control Arm Bushing Kit



**CAMARO Continued...**

**STRUT ARM BUSHINGS**

10-15	Adjustment Link Bushing Kit	7-1214
-------	-----------------------------	--------

**SUBFRAME MOUNTS**

10-15	Rear Subframe Bushing Kit	7-142
10-11	Rear Subframe Inserts	7-146

**SWAY BAR BUSHINGS, Front**

67-81	Front Sway Bar Bushings (See Page 10 For Sway Bar Bushing Listings)	
82-92	Sway Bar Bushing Kit, 28mm	7-241
82-92	Sway Bar Bushing Kit, 30mm Bar	7-1133
82-92	Sway Bar Bushing Kit, 32mm Bar	7-1134
82-92	Sway Bar Bushing Kit, 34mm Bar	7-1135
93-02	Sway Bar Bushing Kit, 30mm Bar	7-1136
93-02	Sway Bar Bushing Kit, 32mm Bar	7-1137
10-15	Sway Bar Bushing Kit (Front & Rear)	7-1192

**SWAY BAR BUSHINGS & END LINKS, Rear**

**(2 Bolt Clamp)**

67-81	Sway Bar & End Link Bushing Kit, 9/16" Bar	7-1116
67-81	Sway Bar & End Link Bushing Kit, 5/8" Bar	7-1117
67-81	Sway Bar & End Link Bushing Kit, 11/16" Bar	7-1118
67-81	Sway Bar & End Link Bushing Kit, 3/4" Bar	7-1119
67-81	Sway Bar & End Link Bushing Kit, 13/16" Bar	7-1120
67-81	Sway Bar & End Link Bushing Kit, 7/8" Bar	7-1121

**SWAY BAR BUSHINGS & END LINKS, Rear**

**(1 Bolt Clamp)**

67-81	Sway Bar & End Link Bushing Kit, 5/8" Bar	7-1122
67-81	Sway Bar & End Link Bushing Kit, 11/16" Bar	7-1123
67-81	Sway Bar & End Link Bushing Kit, 3/4" Bar	7-1124
67-81	Sway Bar & End Link Bushing Kit, 13/16" Bar	7-1125
67-81	Sway Bar & End Link Bushing Kit, 7/8" Bar	7-1126
67-81	Sway Bar & End Link Bushing Kit, 15/16" Bar	7-1127
67-81	Sway Bar & End Link Bushing Kit, 1" Bar	7-1128

**SWAY BAR BUSHINGS & END LINKS, Rear**

**(Late Model)**

82-02	Sway Bar Bushing & End Link Kit, 19mm Bar	7-1129
82-02	Sway Bar Bushing & End Link Kit, 21mm Bar	7-1130
82-02	Sway Bar Bushing & End Link Kit, 23mm Bar	7-1131
82-02	Sway Bar Bushing & End Link Kit, 24mm Bar	7-1132
10-15	Sway Bar Bushing Kit (Front & Rear)	7-1192

**SWAY BAR END LINKS**

67-92	Front Sway Bar End Link Kit	19-406
93-02	Front Sway Bar End Link Kit	19-409

**TIE ROD BOOTS**

67-02	Tie Rod Boot Kit (2)	19-1712
-------	----------------------	---------

**TRANSMISSION MOUNTS**

67-02	Transmission Mount Kit (6 & 8 Cylinder)	7-1604
82-92	Secondary Trans. Crossmember Bushing Kit	7-1605

**TOTAL KITS**

67-69	Total Kit (Mono Leaf, Incl. Transmission Mount)	7-2002
67-69	Total Kit (Multi Leaf, Incl. Transmission Mount)	7-2040
70-72	Total Kit (Includes Transmission Mount)	7-2028
73-74	Total Kit (Includes Transmission Mount)	7-2029
75-79	Total Kit (Includes Transmission Mount)	7-2005
80-81	Total Kit (Includes Transmission Mount)	7-2030
82-92	Total Kit (Includes Transmission Mount)	7-2008
93-02	Total Kit (Includes Transmission Mount)	7-2009
10-15	Total Kit (Incl. Complete Sub-Frame Bush.)	7-2044
10-11	Total Kit (w/Sub-Frame Inserts)	7-2045

**Chevrolet Chevelle, El Camino & Monte Carlo**

**BALL JOINT BOOTS**

64-72	Ball Joint Boot Kit (4)	19-1715
73-88	Ball Joint Boot Kit (4)	19-1717

**BODY MOUNTS**

64	Body Mount Kit (Hardtop & Convertible)	7-137
65-67	Body Mount Kit	7-121
65-67	Body Mount Kit (Convertible Only)	7-122
68-72	Body Mount Kit (Except 70-72 Monte Carlo)	7-123
68-72	Body Mount Kit (Convertible Only)	7-124
68-72	Body Mount Kit (El Camino Only)	7-125
70-72	Body Mount Kit (Monte Carlo Only)	7-126
78-88	Body Mount Kit	7-132

**CONTROL ARM BUSHINGS, Front**

64-65	Control Arm Bushing Kit, w/Shells	7-221
66	Control Arm Bushing Kit, w/Shells (w/ 1.90" OD Lower)	7-221
66	Control Arm Bushing Kit, w/Shells (w/ 1.65" OD Lower)	7-217
67-72	Control Arm Bushing Kit, w/Shells (Oval Lower)	7-222
67-72	Cont. Arm Bushing Kit, w/Shells (Round Lower)	7-217
73	Control Arm Bushing Kit, w/Shells (w/ 1.625" OD Ft. Lower)	7-212
73	Control Arm Bushing Kit, w/Shells (w/ 1.375" OD Ft. Lower)	7-213
74	Control Arm Bushing Kit, w/Shells (w/ 1.625" OD Ft. Lower)	7-214
74	Control Arm Bushing Kit, w/Shells (w/ 1.375" OD Ft. Lower)	7-215
75-77	Control Arm Bushing Kit, w/Shells	7-214
78-88	Control Arm Bushing Kit, w/Shells	7-223

**CONTROL ARM BUSHINGS, Rear**

64	Control Arm Bushing Kit, w/o Shells	7-314
65-88	Control Arm Bushing Kit, w/Shells	7-225

**COIL SPRING ISOLATORS, Rear**

67-88	Coil Spring Isolators, Rear Uppers	7-1706
-------	------------------------------------	--------

**MOTOR MOUNTS**

Various (See Application Charts on Pages 14-19)

**RADIATOR ISOLATORS**

**(Chevelle & El Camino)**

68-72	Radiator Isolators, Small Block (4pcs)	7-1711
68-72	Radiator Isolators, Big Block (4pcs)	7-1712

**RADIATOR ISOLATORS Continued**

**(Monte Carlo)**

70-77	Radiator Isolators, Small Block (4pcs)	7-1711
70-77	Radiator Isolators, Big Block (4pcs)	7-1712

**SWAY BAR BUSHINGS, Front**

64-88	Front Sway Bar Bushings (See Page 8 For Sway Bar Bushing Listings)
-------	--

**SWAY BAR END LINKS, Front**

64-72	Sway Bar End Link Kit	19-409
73-77	Sway Bar End Link Kit	19-408
78-88	Sway Bar End Link Kit	19-412

**TIE ROD BOOTS**

64-88	Tie Rod Boot Kit (2)	19-1712
-------	----------------------	---------

**TRANSMISSION MOUNTS**

Various (See Application Charts on Pages 10 to 19)

**TOTAL KITS**

68-73	Total Kit (Chevelle, Incl. Transmission Mount)	7-2003
73-77	Total Kit (Chevelle, Malibu, El Camino, Laguna, Includes Transmission Mount)	7-2004
78-88	Total Kit (Chevelle, Malibu, El Camino, Monte Carlo, Includes Transmission Mount)	7-2007

## GM LS-1 Motor Mount Adapter Kit

Here is the answer to those LS-1 engine swaps where the mounts just don't line up with the proper frame location. Made of fully machined 6061 T-6 billet aluminum and provided with all the correct hardware to complete the installation. All kits include a pair of our hi-performance interlocked urethane Motor Mounts to complete the kit. Refer to the Motor & Transmission Mount chart pages for your specific application. (Add "-BL" for black after part number.)

**#7-519 LS-1 Adapter Plate Kit, includes our "A" #7-504 mounts**  
(also referred to as a factory short & wide mount)

**#7-520 LS-1 Adapter Plate Kit, includes our "B" #7-505 mounts**  
(also referred to as a factory tall & narrow mount)

**#7-524 LS-1 Adapter Plate Kit, includes our #7-509 mounts** (mount is common on '63-'72 GM pickup trucks)

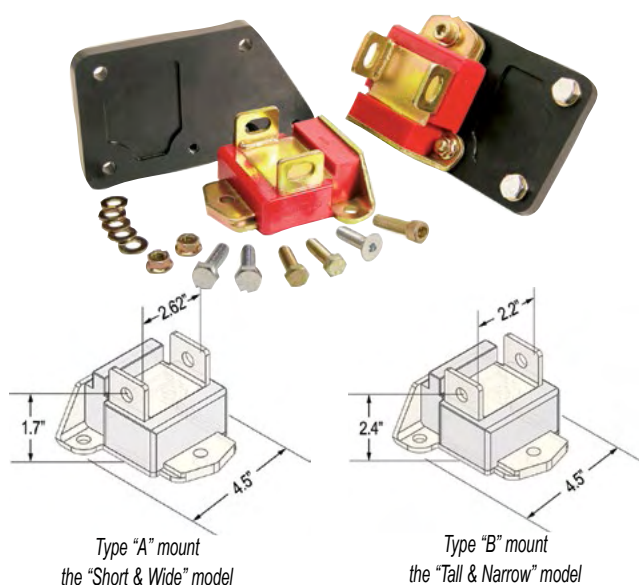

Type "A" mount  
the "Short & Wide" model

Type "B" mount  
the "Tall & Narrow" model



#7-524 LS-1 Adapter Plate Kit, includes our #7-509 mounts

## Chevrolet Corvette

### BALL JOINT BOOTS

63-96	Ball Joint Boot Kit (4)	19-1715
-------	-------------------------	---------

### BODY MOUNT

63-69	Body Mount Kit	7-128
73-82	Body Mount Kit	7-133

### CONTROL ARM BUSHINGS, Front

63-82	Front Control Arm Bushing Kit, w/Shells	7-210
84-96	Front Control Arm Bushing Kit, w/o Shells	7-228
97-13	Front Control Arm Bushing Kit, w/o Shells	7-232

### CONTROL ARM BUSHINGS, Rear

63-82	Rear Control Arm Bushing Kit, w/o Shells	7-303
84-96	Rear Control Arm Bushing Kit, w/o Shells	7-315
97-13	Rear Control Arm Bushing Kit, w/o Shells	7-316

### DRIVE TRAIN

80-82	Differential Carrier Bushing Kit	7-1607
63-82	Differential Pinion Mount Grommet Kit	7-1606
84-96	Differential Carrier Bushing Kit	7-1610
10-13	Six Shooter™ Driveline Coupler 10mm	7-1650
10-13	Six Shooter™ Driveline Coupler 12mm	7-1651

*Our couplers are designed as factory performance replacements and not for racing.*

### MOTOR MOUNTS

63-13	Motor Mount Kit (See Application Charts on Pages 14-19)	
84-96	Motor Mount Insert Kit	7-522

### RADIATOR ISOLATORS

84-89	Radiator Isolator Kit C4	7-1718
90-96	Radiator Isolator Kit C5	7-1719
97-04	Radiator Isolator Kit C6	7-1717
05-11	Radiator Isolator Kit C7	7-1720

### SPRING EYE & SHACKLE BUSHINGS

54-62	Spring Eye & Shackle Bushing Kit, Rear	7-1021
-------	--	--------

### SPRING CUSHIONS

63-82	Rear Spring Cushion Kit	7-1019
84-96	Rear Spring Cushion Kit	7-1020
97-04	Rear Spring Cushion Kit	7-1025

### STEERING

63-82	Power Steering Ram Bushing Kit	7-701
84-96	Rack & Pinion Bushing Kit	7-702

### STRUT ROD BUSHINGS

63-74	Strut Rod Bushing Kit, Rear	7-1202
75-82	Strut Rod Bushing Kit, Rear	7-1203
84-87	Strut Rod Bushing Kit, Rear*	7-1204
88-96	Strut Rod Bushing Kit, Rear**	7-1205

(\*Strut Eye Same Size Each End)

(\*\*Strut Eye Different Size Each End, Re-Use All Metal Parts)

### Corvette Generations & Years

Gen.	Years	Gen.	Years
C1	1953 to '62	C5	1997 to '04
C2	1963 to '67	C6	2005 to '13
C3	1968 to '82	C7	2014 to '18
C4	1984 to '96		



## CORVETTE C continued...

### SWAY BAR BUSHINGS & END LINKS, Front

84-87	Sway Bar & End Link Bushing Kit, 22mm Bar	7-1146
84-87	Sway Bar & End Link Bushing Kit, 24mm Bar	7-1147
84-87	Sway Bar & End Link Bushing Kit, 26mm Bar	7-1148
84-87	Sway Bar & End Link Bushing Kit, 30mm Bar	7-1149
84-87	Sway Bar & End Link Bushing Kit, 32mm Bar	7-1173
88-96	Sway Bar & End Link Bushing Kit, 22mm Bar	7-1150
88-96	Sway Bar & End Link Bushing Kit, 24mm Bar	7-1151
88-96	Sway Bar & End Link Bushing Kit, 26mm Bar	7-1152
88-96	Sway Bar & End Link Bushing Kit, 30mm Bar	7-1153
88-96	Sway Bar & End Link Bushing Kit, 32mm Bar	7-1174
97-04	Sway Bar Bushing Kit, 23mm Bar	7-1163
97-04	Sway Bar Bushing Kit, 26mm Bar	7-1164
97-04	Sway Bar Bushing Kit, 32mm Bar	7-1177
97-04	Sway Bar Bushing Kit, 38mm Bar	7-1178
97-06	Sway Bar Bushing Kit, 28.6mm Bar	7-1191
96-06	Sway Bar Bushing Kit, 30mm Bar	7-1176

### SWAY BAR BUSHINGS & END LINKS, Rear

63-82	Sway Bar & End Link Bushing Kit, 7/16" Bar	7-1141
84-96	Sway Bar & End Link Bushing Kit, 19mm Bar	7-1142
84-96	Sway Bar & End Link Bushing Kit, 22mm Bar	7-1143
84-96	Sway Bar & End Link Bushing Kit, 24mm Bar	7-1144
84-96	Sway Bar & End Link Bushing Kit, 26mm Bar	7-1145
97-04	Sway Bar Bushing Kit, 19mm Bar	7-1165
97-04	Sway Bar Bushing Kit, 22mm Bar	7-1166
97-06	Sway Bar Bushing Kit, 23mm Bar	7-1189
97-04	Sway Bar Bushing Kit, 26mm Bar	7-1180
97-06	Sway Bar Bushing Kit, 27mm Bar	7-1179

### SWAY BAR END LINKS

63-82	Front End Link Kit	19-405
63-96	Rear End Link Kit	7-401
84-87	Front End Link Kit	7-402
88-96	Front End Link Kit	7-403

### TIE ROD BOOTS

All	Tie Rod Boot Kit (2)	19-1712
-----	----------------------	---------

### TRANSMISSION MOUNTS

63-82	Transmission Mount Kit	7-1604
14-17	SS Transmission Mount Custom Billet Kit	7-1615

### TOTAL KITS

63-82	Total Kit (Includes Transmission Mount)	7-2012
84-96	Total Kit	7-2013
97-13	Total Kit	7-2014



#7-2012 Corvette '63-'82 Total Kit



# 7-503 55-57 Motor Mount Kit, 265/283 Stock V8

## Chevrolet Bel Air, Biscayne, Caprice & Impala

### BALL JOINT BOOTS

64-74	Ball Joint Boot Kit (4)	19-1715
75-96	Ball Joint Boot Kit (4)	19-1717

### BODY MOUNTS

55-57	Body Mount Kit (2 & 4 Door Sedans)	7-129
55-57	Body Mount Kit (Convertible Only)	7-130
55-57	Body Mount Kit (2 Door Hardtop Only)	7-131
59-64	Body Mount Kit (Sedan)	7-144
59-64	Body Mount Kit (Convertible Only)	7-145
65-70	Body Mounts Kit (2 Door Hardtop Only)	7-134
65-70	Body Mount Kit (Impala Convertible Model)	7-149

### COIL SPRING ISOLATORS, Rear

71-90	Coil Spring Isolator Kit, Rear Uppers	7-1706
91-96	Coil Spring Isolator Kit, Rear Uppers	7-1710

### CONTROL ARM BUSHINGS, Front

55-64	Control Arm Bushing Kit, w/Shells	7-210
65-70	Control Arm Bushing Kit, Upper w/Shells, Lower w/o Shells	7-211
71-72	Control Arm Bushing Kit, w/Shells	7-212
73	Control Arm Bushing Kit, w/Shells (w/ 1.625" OD Fl. Lower)	7-212
73	Control Arm Bushing Kit, w/Shells (w/ 1.375" OD Fl. Lower)	7-213
74	Control Arm Bushing Kit, w/Shells (w/ 1.625" OD Fl. Lower)	7-214
74	Control Arm Bushing Kit, w/Shells (w/ 1.375" OD Fl. Lower)	7-215
75-79	Control Arm Bushing Kit, w/Shells	7-214
80-90	Control Arm Bushing Kit, w/Shells	7-216
91-96	Control Arm Bushing Kit, w/Shells	7-230

### CONTROL ARM BUSHINGS, Rear

59-64	Cont. Arm Bush. Kit, w/o Shells (Single Upper Arm)	7-307
59-64	Cont. Arm Bush. Kit, w/o Shells (Two Upper Arms)	7-308
65-70	Cont. Arm Bush. Kit, w/o Shells (Single Upper Arm)	7-309
65-70	Cont. Arm Bush. Kit, w/o Shells (Two Upper Arms)	7-310
69-70	Cont. Arm Bushing Kit, w/o Shells (V8's Only)	7-313
71-77	Cont. Arm Bush. Kit, w/o Shells (Exc Strn. Wagon)	7-311
78-96	Control Arm Bushing Kit, w/o Shells	7-312

### LEAF SPRING & SHACKLE, Rear

55	Spring Eye & Shackle Bushing Kit	7-1022
56-57	Spring Eye & Shackle Bushing Kit	7-1023

### MOTOR MOUNTS

55-57	Motor Mount Kit, 265/283 Stock V8	7-503
Various	(See Application Chart on Page 14-19)	

### RADIATOR ISOLATORS

70-80	Radiator Isolators, Small Block (4pcs)	7-1711
70-81	Radiator Isolators, Big Block (4pcs)	7-1712

### TRACK BAR BUSHINGS, Rear

59-64	Track Bar Bushing Kit, Rear, Panhard	7-1209
65-70	Track Bar Bushing Kit, Rear, Panhard	7-1207
65-70	Track Bar Bushing Kit, Rear, Panhard (Both Ends the Same 1-1/8" I.D.)	7-1208

### STRUT ROD BUSHINGS

65-70	Front Strut Rod Bushing Kit	7-1211
-------	-----------------------------	--------

### SWAY BAR BUSHINGS, Front

55-90	Front Sway Bar Bushings	(See Page 10 For S/B Bushing Listings)
-------	-------------------------	--

### SWAY BAR END LINKS, Front

55-57	End Link Kit	19-408
58-64	End Link Kit	19-412
65-70	End Link Kit	19-405
71-90	End Link Kit	19-408
91-96	End Link Kit	19-406

### TIE ROD BOOTS

55-96	Tie Rod Boot Kit (2)	19-1712
-------	----------------------	---------

### TRANSMISSION MOUNTS

Various	(See Application Chart on Page 13)	
---------	------------------------------------	--

### TOTAL KITS

55-57	Total Kit (Sedan & Hardtop, Includes Trans. & V8 Motor Mounts)	7-2010
59-64	Total Kit (Includes Transmission Mount)	7-2032
65-70	Total Kit (2 Door Hardtop Only, Incl. Trans. Mount)	7-2015
65-70	Total Kit (Impala Convertible)	7-2048
80-90	Total Kit (Includes Transmission Mount)	7-2026

## Chevrolet Nova

### BALL JOINT BOOTS

62-74	Ball Joint Boot Kit (4)	19-1715
75-79	Ball Joint Boot Kit (4)	19-1717

### BODY MOUNTS

68-74	Body Mount Kit	7-119
68-74	Body Mount Kit with Hardware	7-139
68-74	Body Mount Hardware Kit Only	7-140

### BUMP STOPS

68-72	Front Lower C-Arm Bump Stops (2)	7-1301
-------	----------------------------------	--------

### CONTROL ARM BUSHINGS, Front

62-67	Control Arm Bushing Kit, w/o Shells	7-229
68-74	Control Arm Bushing Kit, w/Shells	7-217
75-79	Control Arm Bushing Kit, w/Shells	7-214

### MOTOR MOUNTS

Various (See Application Charts on Pages 14-19)

### RADIATOR ISOLATORS

68-79	Radiator Isolators, Small Block (4pcs)	7-1711
68-79	Radiator Isolators, Big Block (4pcs)	7-1712

### SPRING & SHACKLE, OEM & HEAVY DUTY REAR

62-67	Spring Eye & Shackle Bushing Kit (Mono Leaf)	7-1018
62-67	Spring Eye & HD Shackle Bushing Kit (Mono Leaf)**	7-1056
68-74	Spring Eye & Shackle Bushing Kit (Mono Leaf)	7-1010
68-79	Spring Eye & Shackle Bushing Kit (Multi Leaf)	7-1011
62-74	HD Shackle Kit Only (Mono Leaf)*	7-1053
68-79	HD Shackle Kit Only (Multi Leaf)*	7-1051
68-74	Spring Eye & HD Shackle Kit (Mono Leaf)**	7-1052
68-79	Spring Eye & HD Shackle Kit (Multi Leaf)**	7-1050

(\*Includes rear eye bushings, zinc plated heavy duty steel shackles, bolts & locknuts.)

\*\*Includes both spring eye bushings, shackle bushings, zinc plated heavy duty steel shackles, bolts & locknuts.

### SPRING PADS, Rear

62-74	Spring Pad Kit, Upper (Mono Leaf)	7-1704
62-74	Spring Pad Kit, Lower (Mono Leaf)	7-1705
68-79	Spring Pad Kit, Upper or Lower (Multi Leaf)	7-1701
62-74	Spring Pad Kit, Upper & Lower (Mono Leaf), 4Pc.	7-1707
68-79	Spring Pad Kit, Upper & Lower (Multi Leaf), 4Pc.	7-1708

### STRUT ARM BUSHINGS

62-67	Front Strut Arm Bushing Kit	7-1206
-------	-----------------------------	--------

### SWAY BAR BUSHINGS, Front

62-79	Front Sway Bar Bushings	(See Page 10 For S/B Bushing Listings)
-------	-------------------------	--

### SWAY BAR END LINKS

62-79	Front End Link Kit	19-406
-------	--------------------	--------

### TIE ROD BOOTS

62-79	Tie Rod Boot Kit (2)	19-1712
-------	----------------------	---------

### TRANSMISSION MOUNTS

Various (See Application Chart on Page 14)

### TOTAL KITS

62-67	Total Kit (Includes Transmission Mount)	7-2011
68-74	Total Kit (Multi Leaf, Incl. Trans. Mount)	7-2040
68-74	Total Kit (Mono Leaf, Incl. Trans. Mount)	7-2002
75-79	Total Kit (w/o Body Mounts, Incl. Trans. Mount)	7-2027

## Chevrolet Vega

### CONTROL ARM BUSHINGS, Front

72-79	Control Arm Bushing Kit	7-280
-------	-------------------------	-------



7-139 '68-'74 Body Mount Kit with Hardware



#7-2026 '80-'90 Total Kit



#7-2002-BL '68-'74 Nova Total Kit

## Chevy/GMC Full Size Trucks

### BALL JOINT BOOTS

63-95	(All Trucks) Ball Joint Boot Kit (4)	19-1820
(Pickup C10, C15, C20, C25, C30, C35 2WD)		
88-98	Ball Joint Boot Kit (4)	19-1716
(Suburban, Yukon 2WD)		
92-97	Ball Joint Boot Kit (4)	19-1716

### BODY & CAB MOUNTS, 2WD

<b>(Avalanche 2WD)</b>		
02-13	Body Mount Kit	7-143
<b>(Denali, Tahoe, Yukon 2WD)</b>		
95-99	20 Bushing Kit	7-136
00-13	Body Mount Kit	7-143
<b>(Denali XL, Suburban, Yukon XL 2WD)</b>		
00-06	Body Mount Kit	7-143
<b>(Pickup 1/2 Ton 2WD)</b>		
63-66	Standard Cab - 8 Bushing Kit	7-118
67-72	Standard Cab - 12 Bushing Kit	7-101
73-80	Standard Cab - 12 Bushing Kit	7-102
81-87	Standard Cab - 12 Bushing Kit	7-108
88-98	Standard Cab - 12 Bushing Kit	7-112
88-98	Extra Cab Only - 16 Bushing Kit	7-113
<b>(Pickup 3/4 &amp; 1 Ton 2WD)</b>		
70-72	Standard Cab - 12 Bushing Kit	7-103
73-80	Standard Cab - 12 Bushing Kit	7-104
75-79	Crew Cab Only - 16 Bushing Kit	7-135
81-87	Standard Cab - 12 Bushing Kit	7-108
81-91	Crew Cab Only - 16 Bushing Kit	7-111
88-98	Standard Cab - 12 Bushing Kit	7-112
88-98	Extra Cab Only - 16 Bushing Kit	7-113
<b>(Silverado &amp; Sierra 1500 2WD)</b>		
99-14	All Cabs - 16 Bushing Kit (Oval Hole)	7-141
99-14	Single Cab - 12 Bushing Kit	7-147
<b>(Silverado &amp; Sierra 2500 3/4 Ton 2WD)</b>		
99-14	All Cabs - 16 Bushing Kit	7-141
<b>(Silverado 2WD &amp; Sierra 1500)</b>		
99-07	All Cabs - 16 Bushing Kit (Round Hole)	7-148
<b>(Suburban 1500 1/2 Ton 2WD)</b>		
81-91	24 Bushing Kit	7-114
<b>(Yukon Hybrid 2WD)</b>		
08-13	Body Mount Kit	7-143

### BODY & CAB MOUNTS, 4WD

<b>(Avalanche 4WD)</b>		
02-13	Body Mount Kit	7-143
<b>(Blazer 1/2 Ton 4WD)</b>		
67-72	24 Bushing Kit	7-105
73-77	20 Bushing Kit	7-106
78-80	20 Bushing Kit	7-107
81-91	20 Bushing Kit	7-110
92-94	20 Bushing Kit (2 Door Only)	7-136
<b>(Denali, Tahoe, Yukon 4WD)</b>		
00-13	Body Mount Kit	7-143
<b>(Denali XL, Suburban, Yukon XL 4WD)</b>		
00-06	Body Mount Kit	7-143
<b>(Pickup 1/2, 3/4 &amp; 1 Ton 4WD)</b>		
67-72	Standard Cab - 12 Bushing Kit	7-103
73-80	Standard Cab - 12 Bushing Kit	7-104
75-79	Crew Cab Only - 16 Bushing Kit	7-135
81-87	Standard Cab - 12 Bushing Kit	7-108
81-91	Crew Cab Only - 16 Bushing Kit	7-111
88-98	Standard Cab - 16 Bushing Kit	7-112
88-98	Extra Cab Only - 16 Bushing Kit	7-113
<b>(Silverado, Sierra 1500 1/2 Ton &amp; Avalanche 4WD)</b>		
99-14	All Cabs - 16 Bushing Kit	7-141 / 7-148*
<b>(Silverado &amp; Sierra 2500 3/4 Ton, 4WD)</b>		
99-14	All Cabs - 16 Bushing Kit	7-141 / 7-148*
10-13	Single Cab - 12 Bushing Kit	7-147
<b>(Silverado 4WD)</b>		
99-07	All Cabs - 16 Bushing Kit	7-141 / 7-148*
<b>(Suburban 1/2 Ton, 4WD)</b>		
81-91	24 Bushing Kit	7-114
<b>(Tahoe, Yukon, 4WD)</b>		
95-99	20 Bushing Kit	7-136

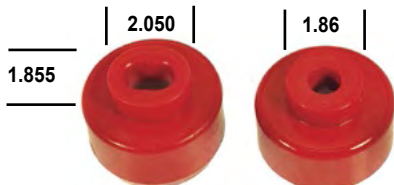

#7-141 (Oval Hole) #7-148 (Round Hole)

\* Body Mounts Note: GM changed Body Mount styles on same year models. Please check diameter as shown, before ordering.

### COIL SPRING LIFT SPACERS

<b>(Avalanche, Silverado &amp; Sierra 1500, Suburban, Tahoe, Yukon, 2 &amp; 4WD)</b>		
07-09	Front Coil Spring Lift Kit, 2" Lift	7-1716
<b>(Pickup 1/2 Ton, 2WD)</b>		
88-98	Front Coil Spring Lift Kit, 1" Lift	7-1715

### CONTROL ARM BUSHINGS, Front 2WD

<b>(Astro Van, 2WD)</b>		
85-98	Control Arm Bushing Kit, w/Shells	7-216
<b>(Avalanche 1500 &amp; 2500, 2WD)</b>		
02-07	Control Arm Bushing Kit	7-236
<b>(Full Size Blazer To 94, Suburban &amp; Tahoe 1/2 Ton, 2WD)</b>		
73-91	Control Arm Bushing Kit, w/o Shells	7-201
92-99	Control Arm Bushing Kit, w/o Shells	7-205
<b>(C10 &amp; C20 Pickup, 2WD)</b>		
73-87	Control Arm Bushing Kit, w/o Shells	7-201
88-01	Control Arm Bushing Kit, w/o Shells	7-205
<b>(C1500 Pickup, 2WD)</b>		
88-02	Control Arm Bushing Kit, w/o Shells	7-205
<b>(P-10 Chassis, 2WD)</b>		
73-82	Control Arm Bushing Kit, w/o Shells (Upper Bushings Only)	7-202
<b>(Silverado &amp; Sierra 1500 &amp; 2500, 2WD)*</b>		
99-07	Control Arm Bushing Kit, w/o Shells (old truck body)	7-236
07-14	Control Arm Bushing Kit, w/o Shells	7-243
<b>(Silverado &amp; Sierra 2500 3/4 Ton, 2WD)*</b>		
01-07	Control Arm Bushing Kit, w/o Shells	7-237
<b>(1500HD, 2500HD &amp; 3500HD, 2WD)*</b>		
01-13	Control Arm Bushing Kit, w/o Shells	7-237
<b>(Suburban 1500, 2500, Tahoe, Yukon, 2WD)</b>		
99-07	Control Arm Bushing Kit	7-236
<b>(Van 1/2, 3/4 Ton, G-10, G-20, 2WD)</b>		
73-95	Control Arm Bushing Kit, w/o Shells	7-201

### CONTROL ARM BUSHINGS, Front 4WD

<b>(Avalanche 1500, 4WD)</b>		
02-07	Control Arm Bushing Kit	7-236
<b>(Full Size Blazer To 94, Suburban &amp; Tahoe 4WD, 1/2 Ton)</b>		
92-99	Control Arm Bushing Kit, w/o Shells	7-206
<b>(Pickup 1/2, 3/4 &amp; 1 Ton, 4WD)</b>		
88-98	Control Arm Bushing Kit, w/o Shells	7-206
<b>(Silverado &amp; Sierra 1500 4WD)*</b>		
99-07	Control Arm Bushing Kit	7-236
<b>(Silverado 1500HD, 2500HD, 3500HD, 4WD)*</b>		
01-13	Control Arm Bushing Kit	7-237
<b>(Silverado &amp; Sierra 1500 &amp; 2500 4WD)*</b>		
07-12	Control Arm Bushing Kit, w/o Shells	7-243
<b>(Silverado &amp; Sierra 2500 3/4 Ton, 4WD)*</b>		
01-06	Control Arm Bushing Kit, w/o Shells	7-237
07-14	Control Arm Bushing Kit, w/o Shells	7-243
<b>(Suburban 1500 &amp; Yukon 4WD)</b>		
02-06	Control Arm Bushing Kit	7-236
<b>(Tahoe 4WD)</b>		
00-07	Control Arm Bushing Kit	7-236
<b>(Trail Blazer SS 4WD)</b>		
02-09	Control Arm Bushing Kit, w/o Shells	7-242
<b>(Yukon XL 1500 &amp; 2500 4WD)</b>		
00-06	Control Arm Bushing Kit	7-236

\* Does not fit Z71 Models



#7-205 Control Arm Bushing Kit, w/o Shells C1500 Pickup

Continued...

## CONTROL ARM BUSHINGS & TRACK BAR, Rear 2WD

<b>(Pickup 1/2 Ton, 2WD)</b>		
60-72	Track Bar Bushing Kit, w/o Shells	7-302
63-72	Control Arm Bushing Kit, w/o Shells	7-301

## CONTROL ARM BUSHINGS, Rear 2 & 4WD

<b>(Envoy, Rainer, Trailblazer)</b>		
02-09	Rear Control Arm Bushing Kit	7-321

## DRIVETRAIN

<b>(Silverado &amp; Sierra Crew Cabs 1500 &amp; 2500, 4WD)</b>		
07-14	Front Differential Mount Kit	7-1614

## MOTOR MOUNTS

Various (See Application Charts on Pages 14-19)

## RADIATOR ISOLATORS

<b>(Pickup 1/2, 3/4 &amp; 1 Ton, 2 &amp; 4WD)</b>		
73-87	Radiator Isolators, Small Block (4 pcs)	7-1711
73-87	Radiator Isolators, Big Block (4 pcs)	7-1712
88-98	Radiator Isolators, Small Block (4 pcs)	7-1713
88-98	Radiator Isolators, Big Block (4 pcs)	7-1714

## SPRING & SHACKLE BUSHINGS, Rear 2WD

<b>(Pickup 1/2, 3/4 &amp; 1 Ton, 2WD)</b>		
88-98	Spring Eye & Shackle Bushing Kit (w/ 1-3/8" OD Frame Shackle Bushings)	7-1017
88-98	Spring Eye & Shackle Bushing Kit (w/ 1-1/2" OD Frame Shackle Bushings)	7-1054
88-98	Frame Shackle Bushing Kit, 1-1/2" OD	7-807
<b>(Silverado &amp; Sierra Crew Cabs 1500 &amp; 2500 1/2 Ton, 2WD)</b>		
99-14	Spring Eye & Shackle Bushing Kit	7-1055
<b>(Pickup 1/2, 3/4, 1 Ton w/1550 to 2000 lbs. Spring Rating 2WD)</b>		
67-87	Spring Eye & Shackle Bushing Kit (w/ 1-1/2" OD Frame Shackle Bushings)	7-1001
73-87	Frame Shackle Bushing Kit, 1-1/2" OD	7-803
81-87	Spring Eye & Shackle Bushing Kit (w/ 1-3/8" OD Frame Shackle Bushings)	7-1002
81-87	Frame Shackle Bushing Kit, 1-3/8" OD	7-802
<b>(Pickup 3/4, 1 Ton 2WD with 2600 to 3500 lbs. Spring Rating)</b>		
73-87	Frame Shackle Bushing Kit, 1-1/2" OD	7-803
73-87	Frame Shackle Bushing Kit, 1-3/4"	7-804
73-87	Spring Eye & Shackle Bushing Kit (w/ 1-1/2" OD Frame Shackle Bushings)	7-1003
73-87	Spring Eye & Shackle Bushing Kit (w/ 1-3/4" OD Frame Shackle Bushings)	7-1008
81-87	Spring Eye & Shackle Bushing Kit (w/ 1-3/8" OD Frame Shackle Bushings)	7-1004
81-87	Frame Shackle Bushing Kit, 1-3/8" OD	7-802
<b>(Full Size Blazer To '94, Suburban &amp; Tahoe, 1/2 Ton, 2WD)</b>		
67-91	Spring Eye & Shackle Bushing Kit (w/ 1-1/2" OD Frame Shackle Bushings)	7-1001
67-91	Spring Eye & Shackle Bushing Kit (w/ 1-3/8" OD Frame Shackle Bushings)	7-1002
67-91	Frame Shackle Bushing Kit, 1-3/8" OD	7-802
67-91	Frame Shackle Bushing Kit, 1-1/2" OD	7-803
<b>(Van G2500 &amp; G3500)</b>		
96-16	Leaf Spring Bushing Kit	7-1058
92-99	Frame Shackle Bushing Kit, 1-3/8" OD	7-805
92-99	Spring Eye & Shackle Bushing Kit (w/ 1-3/8" OD Frame Shackle Bushings)	7-1017

## SPRING & SHACKLE BUSHINGS, Front 4WD

<b>(Pickup 1/2, 3/4, 1 Ton, 4WD)</b>		
67-70	Spring Eye & Shackle Bushing Kit (w/ Frame Shackle Bushings)	7-1014
67-70	Frame Shackle Bushing Kit	7-806
71-87	Frame Shackle Bushing Kit	7-801
71-87	Spring Eye & Shackle Bushing Kit (w/ Frame Shackle Bushings)	7-1007
<b>(Full Size Blazer &amp; Suburban, 1/2 Ton, 4WD)</b>		
67-70	Spring Eye & Shackle Bushing Kit (w/ Frame Shackle Bushings)	7-1014
67-70	Frame Shackle Bushing Kit	7-806
71-91	Frame Shackle Bushing Kit	7-801
71-87	Spring Eye & Shackle Bushing Kit (w/ Frame Shackle Bushings)	7-1007
88-91	Spring Eye & Shackle Bushing Kit (w/ Frame Shackle Bushings)	7-1013
<b>(Pickup, Blazer &amp; Suburban w/ After Market Springs, 4WD)</b>		
69-87	Spring Bushing Kit w/Superlift Springs (Pickup) (Replacement For SL #315) *	7-1009
* (Does Not Include Frame Shackle Bushings)		
71-91	Frame Shackle Bushing Kit	7-801
73-87	Spring & Shackle Bush. w/Rancho Springs (Pickup) (Replacement For RS #954)	7-1015
88-91	Spring & Shackle Bushings w/Rancho Springs (Blazer & Suburban)	7-1024



#7-1009-BL Pickup, Blazer & Suburban w/ After Market Springs, 4WD) Spring Bushing Kit w/Superlift Springs (Pickup)

#7-1054 Full Size Truck '88-'98 Rear Spring & Shackle Bushing Kit



## Chevy/GMC Full Size Trucks

### SPRING & SHACKLE BUSHINGS, Rear 4WD

#### (Pickup 1/2 Ton, 4WD)

67-87	Frame Shackle Bushing Kit, 1-3/8" OD	7-802
67-87	Frame Shackle Bushing Kit, 1-1/2" OD	7-803
67-87	Spring Eye & Shackle Bushing Kit (w/1-1/2" OD Frame Shackle Bushings)	7-1001
81-87	Spring Eye & Shackle Bushing Kit (w/1-3/8" OD Frame Shackle Bushings)	7-1002
88-98	Spring Eye & Shackle Bushing Kit (w/1-3/8" OD Frame Shackle Bushings)	7-1017
88-98	Spring Eye & Shackle Bushing Kit (w/1-1/2" OD Frame Shackle Bushings)	7-1054
88-98	Frame Shackle Bushing Kit, 1-3/8" OD	7-805
88-98	Frame Shackle Bushing Kit, 1-1/2" OD	7-807
99-14	Spring Eye & Shackle Bushing Kit	7-1055

#### (Pickup 3/4 Ton, 4WD)

67-87	Spring Eye & Shackle Bushing Kit (w/Frame Shackle Bushings)	7-1001
67-87	Frame Shackle Bushing Kit, 1-1/2" OD	7-803
88-98	Spring Eye & Shackle Bushing Kit (w/1-3/8" OD Frame Shackle Bushings)	7-1017
88-98	Spring Eye & Shackle Bushing Kit (w/1-1/2" OD Frame Shackle Bushings)	7-1054
88-98	Frame Shackle Bushing Kit, 1-3/8" OD	7-805
88-98	Frame Shackle Bushing Kit, 1-1/2" OD	7-807

#### (Silverado & Sierra Crew Cabs 2500, 4WD)

99-14	Spring Eye & Shackle Bushing Kit	7-1055
-------	----------------------------------	--------

#### (Pickup 1 Ton, 4WD)

67-87	Spring Eye & Shackle Bushing Kit ( w/1-1/2" OD Frame Shackle Bushings)	7-1001
67-87	Frame Shackle Bushing Kit, 1-1/2" OD	7-803
88-98	Spring Eye & Shackle Bushing Kit (w/1-3/8" OD Frame Shackle Bushings)	7-1017
88-98	Spring Eye & Shackle Bushing Kit (w/1-1/2" OD Frame Shackle Bushings)	7-1054

#### (Pickup 1 Ton, 4WD)

88-98	Frame Shackle Bushing Kit, 1-3/8" OD	7-805
88-98	Frame Shackle Bushing Kit, 1-1/2" OD	7-807

#### (Full Size Blazer To '94, Suburban & Tahoe, 1/2 Ton, 4WD)

67-91	Spring Eye & Shackle Bushing Kit (w/1-1/2" Frame Shackle Bushings)	7-1001
67-91	Frame Shackle Bushing Kit, 1-3/8" OD	7-802
67-91	Frame Shackle Bushing Kit, 1-1/2" OD	7-803
81-91	Spring Eye & Shackle Bushing Kit (w/1-3/8" Frame Shackle Bushings)	7-1002
92-99	Spring Eye & Shackle Bushing Kit (w/1-3/8" OD Frame Shackle Bushings)	7-1017
92-99	Frame Shackle Bushing Kit, 1-3/8" OD	7-805

#### (Pickup 3/4 Ton 4WD with 1700 to 2800 lbs. Rating)

73-87	Spring Eye & Shackle Bushing Kit (w/1-1/2" OD Frame Shackle Bushings)	7-1001
73-87	Frame Shackle Bushing Kit, 1-3/8" OD	7-802
81-87	Frame Shackle Bushing Kit, 1-1/2" OD	7-803
81-87	Spring Eye & Shackle Bushing Kit (w/1-3/8" OD Frame Shackle Bushings)	7-1002
88-98	Frame Shackle Bushing Kit, 1-3/8" OD	7-805
88-98	Spring Eye & Shackle Bushing Kit	7-1017

#### (Pickup 3/4, 1 Ton, 4WD with 3000 to 3500 lbs. Rating)

73-87	Spring Eye & Shackle Bushing Kit ( w/1-1/2" OD Frame Shackle Bushings)	7-1003
73-87	Frame Shackle Bushing Kit, 1-3/8" OD	7-802
81-87	Spring Eye & Shackle Bushing Kit (w/1-3/8" OD Frame Shackle Bushings and 1-3/8", 1-1/2", 1-3/4" GM Spring ODS)	7-1004
88-98	Spring Eye & Shackle Bushing Kit (w/1-3/8" OD Frame Shackle Bushings)	7-1017
81-87	Frame Shackle Bushing Kit, 1-1/2" OD	7-803
88-98	Frame Shackle Bushing Kit, 1-3/8" OD	7-805

#### (Pickup 1 Ton, 4WD with 3950 lbs. Rating)

67-72	Spring Eye & Shackle Bushing Kit (w/1-1/2" OD Frame Shackle Bushings)	7-1001
73-87	Spring Eye & Shackle Bushing Kit (w/1-3/4" OD Frame Shackle Bushings)	7-1008
73-87	Frame Shackle Bushing Kit, 1-3/4" OD	7-804
81-87	Spring Eye & Shackle Bushing Kit (w/1-1/2" OD Frame Shackle Bushings)	7-1005
81-87	Spring Eye & Shackle Bushing Kit (w/1-3/8" OD Frame Shackle Bushings)	7-1006
88-98	Spring Eye & Shackle Bushing Kit (w/1-3/8" OD Frame Shackle Bushings)	7-1017
81-87	Frame Shackle Bushing Kit, 1-3/8" OD	7-802
81-87	Frame Shackle Bushing Kit, 1-1/2" OD	7-803
88-98	Frame Shackle Bushing Kit, 1-3/8" OD	7-805

### SWAY BAR BUSHINGS, Front / Rear 2WD

#### (Astro Van)

85-98	Front Sway Bar Bushing Kit, 1-1/4" Bar	7-1110
-------	--	--------

#### (Dually, 2WD)

81-87	Rear Sway Bar Bushing Kit, 1-1/16" Bar* *Includes Frame Brackets	7-1103
-------	---	--------

#### (Pickup 1/2 Ton, C-10, 2WD)

67-87	Front Sway Bar Bushing Kit, 1-1/16" Bar	7-1101
73-87	Front Sway Bar Bushing Kit, 1-1/4" Bar	7-1102
73-87	Front Sway Bar Bushing Kit, 1-1/8" Bar	7-1109

#### (Pickup 3/4 & 1 Ton, 2WD)

70-72	Front Sway Bar Bushing Kit, 1-1/16" Bar	7-1101
73-87	Front Sway Bar Bushing Kit, 1-1/4" Bar	7-1102
88-98	Front Sway Bar Bushing Kit, 1-1/4" Bar	7-1110
99-06	Front Sway Bar Bushing Kit, 1.42" Bar (Includes Heavy Duty Model)	7-1168
88-98	Front Sway Bar Bushing Kit, 1-1/4" Bar	7-1110
99-06	Front Sway Bar Bushing Kit, 1.42" Bar (Includes Heavy Duty Model)	7-1168

#### (Silverado & Sierra Crew Cabs 1500 & 2500, 2WD)

07-14	Front Sway Bar Bushing Kit, 36mm Bar	7-1193
-------	--------------------------------------	--------

#### (Full Size Blazer To '94, Suburban & Tahoe 2WD, 1/2 Ton, 2WD)

73-91	Front Sway Bar Bushing Kit, 1-1/16" Bar	7-1101
73-91	Front Sway Bar Bushing Kit, 1-1/8" Bar	7-1109
73-91	Front Sway Bar Bushing Kit, 1-1/4" Bar	7-1102
92-99	Front Sway Bar Bushing Kit, 1-1/4" Bar	7-1110

#### (Van 1/2 & 3/4 Ton, G-10, G-20, 2WD )

73-94	Front Sway Bar Bushing Kit, 1-1/16" Bar	7-1101
-------	---	--------

#### (Suburban 2WD)

92-99	Rear Sway Bar Bushing Kit, 22mm Bar	7-1140
-------	-------------------------------------	--------

#### (Suburban, Tahoe)

00-05	Front Sway Bar Bushing Kit, 1.25" Bar	7-1169
00-05	Front Sway Bar Bushing Kit, 1.42" Bar	7-1168
00-05	Rear Sway Bar Bushing Kit, 1.10" Bar	7-1171
00-05	Rear Sway Bar Bushing Kit, 1.18" Bar	7-1172

#### (Trailblazer, 2WD)

02-09	Rear Sway Bar Bushing Kit, 24mm Bar NEW	7-1185
02-09	Front Sway Bar Bushing Kit, 44mm Bar NEW	7-1186
02-09	Front Sway Bar Bushing Kit, 46mm Bar NEW	7-1184
04-05	Front Sway Bar Bushing Kit, 34mm Bar	7-1187

### SWAY BAR BUSHINGS, Front / Rear 4WD

#### (Pickup 1/2, 3/4 & 1 Ton, 4WD)

73-80	Front Sway Bar Bushing Kit, 1-1/16" Bar	7-1105
73-80	Front Sway Bar Bushing Kit, 1-1/4" Bar	7-1106
81-87	Front Sway Bar Bushing Kit, 1-1/4" Bar	7-1107
88-98	Front Sway Bar Bushing Kit, 1-1/4" Bar	7-1111
88-98	Front Sway Bar Bushing Kit, 1-3/16" Bar	7-1114
99-03	Front Sway Bar Bushing Kit, 1.13" Bar	7-1170
99-03	Front Sway Bar Bushing Kit, 1.42" Bar (Includes Heavy Duty Model)	7-1168

#### (Silverado & Sierra Crew Cabs 1500 & 2500)

07-14	Front Sway Bar Bushing Kit, 36mm Bar	7-1193
-------	--------------------------------------	--------

#### (Full Size Blazer to 94, Suburban & Tahoe 1/2 Ton, 4WD)

73-80	Front Sway Bar Bushing Kit, 1-1/16" Bar	7-1105
73-80	Front Sway Bar Bushing Kit, 1-1/4" Bar	7-1106

#### (Full Size Blazer to '94, Suburban & Tahoe 1/2 Ton, 4WD)

81-91	Front Sway Bar Bushing Kit, 1-1/4" Bar	7-1107
92-99	Front Sway Bar Bushing Kit, 1-1/4" Bar	7-1111
92-99	Front Sway Bar Bushing Kit, 1-3/16" Bar	7-1114

#### (Suburban & Tahoe 1/2, 3/4 Ton, 4WD)

00-05	Front Sway Bar Bushing Kit, 1.25" Bar	7-1169
00-05	Front Sway Bar Bushing Kit, 1.42" Bar	7-1168
00-05	Rear Sway Bar Bushing Kit, 1.10" Bar	7-1171
00-05	Rear Sway Bar Bushing Kit, 1.18" Bar	7-1172



#7-2021 3/4 Ton Pickup 2WD '88-'98 Total Kit

Continued...

## TIE ROD BOOTS

(Pickup 1/2, 3/4 & 1 Ton, 2 & 4WD)		
63-87	Tie Rod Boot Kit (2)	19-1714
(Blazer & Suburban 1/2 Ton, 2 & 4WD)		
67-91	Tie Rod Boot Kit (2)	19-1714
92-99	Tie Rod Boot Kit (2)	19-1712
(Van 1/2, 3/4 Ton, G-10, G-20, 2WD)		
73-96	Tie Rod Boot Kit (2)	19-1714
(Pickup 1/2, 3/4 & 1 Ton, 2 & 4WD)		
88-98	Tie Rod Boot Kit (2)	19-1712
(Astro Van, 2WD)		
85-98	Tie Rod Boot Kit (2)	19-1712

## TRANSMISSION & DRIVELINE MOUNTS

(Pickup 1/2, 3/4 & 1 Ton, 4WD)		
68-84	Mount Kit, Transmission	7-1601
(1/2, 3/4 & 1 Ton, Full Size Blazer, 4WD)		
60-75	Transfer Case Torque Mount Kit	7-1603
(Full Size Trucks & SUV's)		
Various	(See Application Chart on Page 18)	

## TOTAL KITS

(Pickup 1/2 Ton, 2WD)		
63-66	Total Kit (Includes Transmission Mount)	7-2023
67-72	Total Kit (Includes Transmission Mount)	7-2024
73-80	Total Kit (Includes Transmission Mount)	7-2016
81-87	Total Kit (Includes Transmission Mount)	7-2018
88-98	Total Kit (Includes Transmission Mount)	7-2021
(Silverado & Sierra 1500 2WD)		
99-06	Total Kit (Oval)	7-2042
99-06	Total Kit, Silverado (Round)	7-2050
07-14	Total Kit, Silverado 1500 2WD (Round)	7-2052
07-14	Total Kit, Silverado HD 2WD (Round)	7-2053
(Silverado & Sierra Crew Cabs 1500 & 2500, 2WD)		
07-14	Total Kit (Oval)	7-2046
(Silverado & Sierra Crew Cabs 1500 & 2500, 4WD)		
07-14	Total Kit (Oval)	7-2047
(Pickup 3/4 Ton, 2WD)		
88-98	Total Kit	7-2021
(Silverado 2500HD, 2 & 4WD)		
01-06	Total Kit (Oval)	7-2043
01-06	Total Kit, Silverado 2500 2/4WD (Round)	7-2051
(Pickup 1/2 Ton, 3/4 Ton, 4WD w/ Stock or After Market Springs)		
73-80	Total Kit (Includes Transmission Mount)	7-2017
81-87	Total Kit	7-2019
(Pickup 1/2 Ton, 3/4 Ton & 1 Ton Standard & Extra Cab, 4WD)		
88-98	Total Kit	7-2022
(Suburban 1/2 Ton, 2WD)		
81-87	Total Kit (Includes Transmission Mount)	7-2025
(Blazer, 4WD)		
92-94	Total Kit	7-2035
(Tahoe & Yukon, 4WD)		
95-99	Total Kit	7-2035
(Tahoe & Yukon, 2WD)		
96-99	Total Kit (Includes Transmission Mount)	7-2036



#7-1603 Transfer Case Torque Mount Kit

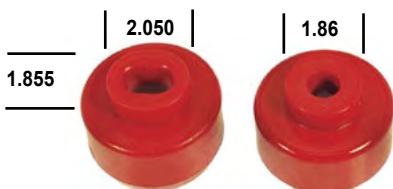

#7-141 (Oval Hole) #7-148 (Round Hole)

**Body Mounts Note: GM changed Body Mount styles on same year models. Please check diameter as shown, before ordering.**

## Chevy/GMC Blazer, Jimmy & S-Series 2WD '82-04 & 4WD '83-04

### BODY & CAB MOUNTS, 2WD

82-04	Standard Cab Pickup - 12 Bushing Kit	7-115
82-04	Extended Cab Pickup - 16 Bushing Kit	7-116
82-04	S10 Blazer - 20 Bushing Kit	7-117

### BODY & CAB MOUNTS, 4WD

83-04	Standard Cab Pickup - 12 Bushing Kit	7-115
83-04	Extended Cab Pickup - 16 Bushing Kit	7-116
83-04	S10 Blazer-20 Bushing Kit	7-117

### CONTROL ARM BUSHINGS, Front 2WD

82-04	Control Arm Bushing Kit (w/o Shells)	7-203
82-04	Control Arm Bushing Kit (w/ Shells)	7-231

### CONTROL ARM BUSHINGS, Front 4WD

83-04	Control Arm Bushing Kit	7-204
-------	-------------------------	-------

### SPRING & SHACKLE BUSHINGS, Rear 2WD

82-04	Spring Eye & Shackle Bushing Kit (w/1-1/2" Spring Eyes) (Does not fit Extreme Model)	7-1016
-------	--	--------

### SPRING & SHACKLE BUSHINGS, Rear 4WD

83-04	Spring Eye & Shackle Bushing Kit (w/1-1/2" Spring Eyes)	7-1016
-------	---	--------

### SWAY BAR BUSHINGS, Front / Rear 2WD

82-04	Front Sway Bar Bushing Kit, 1" Bar	7-1154
82-04	Front Sway Bar Bushing Kit, 1-1/16" Bar	7-1104
82-04	Front Sway Bar Bushing Kit, 1-1/8" Bar	7-1167
82-04	Front Sway Bar Bushing Kit, 33mm Bar	7-1138
82-04	Rear Sway Bar Bushing Kit, 23mm Bar (w/Stud End To Eye Bolt Type End Links)	7-1139
96-04	Rear Sway Bar Bushing Kit, 23mm Bar (w/Eye Bolt To Eye Bolt Type End Links)	7-1175

### SWAY BAR BUSHINGS, Front / Rear 4WD

83-04	Front Sway Bar Bushing Kit, 25mm Bar	7-1112
83-04	Front Sway Bar Bushing Kit, 28mm Bar	7-1113
83-04	Front Sway Bar Bushing Kit, 32mm Bar	7-1155
83-04	Rear Sway Bar Bushing Kit, 23mm Bar (w/Stud End To Eye Bolt Type End Links)	7-1139
96-04	Rear Sway Bar Bushing Kit, 23mm Bar (w/Eye Bolt To Eye Bolt Type End Links)	7-1175

## TRANSMISSION & DRIVELINE MOUNTS

(2WD)		
82-04	Transmission Mount Kit	7-1604
(4WD)		
83-87	Differential Carrier Bushing Kit	7-1602

## TIE ROD BOOTS

82-04	Tie Rod Boot Kit (2)	19-1712
-------	----------------------	---------

## TOTAL KITS

(Pickup 2WD)		
82-04	Total Kit, Standard Cab (Does not fit Extreme Model)	7-2020
82-04	Total Kit, Extended Cab	7-2039
(Pickup 4WD)		
83-04	Total Kit, Standard Cab	7-2033



#7-2022-BL 1/2, 3/4 & 1 Ton 4WD '88-'98 Total Kit

## Chrysler/Dodge/Plymouth/Mid-Size Cars

### BALL JOINT BOOTS

("A", "B" & "E" Body)

62-76	Ball Joint Boot Kit	19-1819
-------	---------------------	---------

### BODY MOUNTS

(Charger, Coronet, Superbee, Roadrunner, Satellite)

73-81	Sub Frame Body Mount Kit, "B" Body	4-101
-------	------------------------------------	-------

### BUMP STOPS

("A", "B", "E" Body)

62-76	Lower Control Arm Bump Stop Kit, "A" Body	19-1303
65-79	Lower Control Arm Bump Stop Kit, "B" Body	19-1303
70-74	Lower Control Arm Bump Stop Kit, "E" Body	19-1303

### CONTROL ARM BUSHINGS, Front

(Dart, Demon, Duster, Swinger, Valiant, Scamp, thru 69 Barracuda)

62-76	C-Arm Bush. Kit "A" Body w/Shells Upper Only	4-225
62-76	C-Arm Bush. Kit, "A" Body w/o Shells Upper Only	4-202
62-76	C-Arm Bush. Kit, "A" Body w/o Shells Lower Only	4-205
62-76	C-Arm Bush. Kit, "A" Body w/o Shells Upper & Lower	4-206
62-76	C-Arm Bush. Kit, "A" Body w/Shells Upper & Lower*	4-215

(Charger, Coronet, Superbee, Roadrunner, Satellite)

62-76	C-Arm Bush. Kit "B" Body w/Shells Upper Only	4-225
65-72	C-Arm Bush. Kit, "B" Body w/o Shells Upper Only	4-202
65-72	C-Arm Bush. Kit, "B" Body w/o Shells Lower Only	4-205
65-72	C-Arm Bush. Kit, "B" Body w/o Shells Upper & Lower	4-206
65-72	C-Arm Bush. Kit, "B" Body w/Shells Upper & Lower*	4-215
73-79	C-Arm Bush. Kit, "B" Body w/o Shells Upper & Lower	4-207

(Challenger, Barracuda)

62-76	C-Arm Bush. Kit "E" Body w/Shells Upper Only	4-225
70-74	C-Arm Bush. Kit, "E" Body w/o Shells Upper Only	4-202
70-74	C-Arm Bush. Kit, "E" Body w/o Shells Lower Only	4-205
70-74	C-Arm Bush. Kit, "E" Body w/o Shells Upper & Lower	4-206
70-74	C-Arm Bush. Kit, "E" Body w/Shells Upper & Lower*	4-215

\*Upper w/Shells, Lower w/o Shells)

(Chrysler 300C, Challenger, Charger, Magnum)

08-14	Control Arm Bushing Kit	4-218
12-14	Control Arm Bushing Kit	4-226

(Dodge Stealth)

94-99	Front Lower Control Arm Bushings	4-227
-------	----------------------------------	-------

### CONTROL ARM BUSHINGS, Rear

(Chrysler 300C, Dodge Challenger, Charger, Magnum)

08-14	Control Arm Bushing Kit	4-220
-------	-------------------------	-------

### DIFFERENTIAL BUSHING KIT

(Chrysler 300C, Dodge Challenger, Charger, Magnum)

08-14	Differential Bushing Kit	4-1607
-------	--------------------------	--------

### MOTOR MOUNTS

Various (See Application Chart on Page 17)

### RACK & PINNION BUSHINGS

(Chrysler 300C, Dodge Challenger, Charger, Magnum)

05-10	Rack and Pinnion Bushing Kit	4-702
-------	------------------------------	-------

### SPRING & SHACKLE BUSHINGS, Rear

(See Chart Below For Listings)

### STRUT ARM BUSHINGS

(Dart, Demon, Duster, Swinger, Valiant, Scamp, thru 69 Barracuda)

66-76	Strut Arm Bushing Kit, "A" Body	4-1202
-------	---------------------------------	--------

(Charger, Coronet, Superbee, Roadrunner, Satellite)

65-74	Strut Arm Bushing Kit, "B" Body	4-1202
-------	---------------------------------	--------

(Challenger, Barracuda)

70-74	Strut Arm Bushing Kit, "E" Body	4-1202
-------	---------------------------------	--------

(MOPAR B/E Body)

66-72	Strut Arm Bushing Kit, "B" Body	4-1207
-------	---------------------------------	--------

66-72	Strut Arm Bushing Kit, "E" Body	4-1207
-------	---------------------------------	--------

### SUB FRAME BUSHINGS

(Chrysler 300C, Dodge Challenger, Charger, Magnum)

08-10	Sub Frame Bushing Kit	4-109
-------	-----------------------	-------



#4-506 Chrysler LX Chassis  
Bullet Style Billet Aluminum  
and Urethane Motor Mounts  
Fits: '12-'15 Challenger,  
Charger, 300c with 3.6L and 5.7L.

### CHRYSLER Dodge/Plymouth (Mid-Size Cars) - SPRING & SHACKLE BUSHINGS, REAR

\*"A" Body (Dart, Demon, Duster, Swinger, Valiant, Scamp, Barracuda thru '69)

Year	Main Eye Bushing Dia.	Main Eye Bolt Dia.	Shackle Bushing Dia.	Part #	Part # w/ HD Shackles
60-62 (Dart)	2"	5/8"	1"	4-1001	4-1010
60-76	2"	5/8"	7/8"	4-1016	4-1015
60-76	1 1/2"	5/8"	7/8"	4-1017	4-1013
60-76	1 1/2"	1/2"	7/8"	4-1004	4-1014
60-76	1 3/8"	7/16"	7/8"	4-1003	4-1012
60-76			1", Shackle Bushing Kit Only	4-802	4-804
60-76			7/8", Shackle Bushing Kit Only	4-801	4-805
60-67	HD Conversion Shackle Kit To Install Super Stock Springs, 4-806				
60-67	Spring Eye & HD S/S Conversion Shackle Kit* 4-1018				
<b>"B" Body (Charger, Coronet, SuperBee, Roadrunner, Satellite &amp; '60-62 Dart)</b>					
60-72	2"	5/8"	1"	4-1001	4-1010
60-72	1 1/2"	5/8"	1"	4-1002	4-1011
60-72			1", Shackle Bushing Kit Only	4-802	4-804
60-62		Spring Eye & HD S/S Conversion Shackle Kit*		4-1018	
73-79	Oval	1/2"	1"	4-1009	
73-79			1", Shackle Bushing Kit Only	4-803	
<b>"E" Body (Challenger, Barracuda '70-74)</b>					
70-74	2"	5/8"	1"	4-1001	4-1010
70-74	1 1/2"	5/8"	1"	4-1002	4-1011
70-74			1" Shackle Bushing Kit Only	7-802	4-804

\*For Installation of Super Stock Springs in a Non S/S Equipped Vehicle

Continued...

## SWAY BAR BUSHINGS & END LINKS

<b>("A" Body- Dart, Demon, Duster, Swinger, Valiant, Scamp, thru 69 Barracuda )</b>		
67-72	Front Sway Bar Bushing Kit, 7/8" Bar	4-1104
67-72	Front Sway Bar Bushing Kit, 15/16" Bar	4-1105
73-76	Front Sway Bar Bushing Kit, 13/16" Bar	4-1107
73-76	Front Sway Bar Bushing Kit, 7/8" Bar	4-1108
73-76	Front Sway Bar Bushing Kit, 15/16" Bar	4-1109
<b>("B"- Charger, Coronet, Superbee, Roadrunner, Satellite)</b>		
65-69	Front Sway Bar Bushing Kit, 7/8" Bar	4-1104
65-69	Front Sway Bar Bushing Kit, 15/16" Bar	4-1105
73-79	Front Sway Bar & End Link Bushing Kit, 13/16" Bar	4-1106
73-79	Front Sway Bar & End Link Bushing Kit, 15/16" Bar	4-1116
<b>("E" Body- Challenger, Barracuda, "Cuda")</b>		
70-74	Front Sway Bar Bushing Kit, 7/8" Bar	4-1108
<b>(Aspen)</b>		
76-79	Front Sway Bar & End Link Bushing Kit, 15/16" Bar	4-1112
76-79	Front Sway Bar End End Link Bushing Kit, 1" Bar	4-1113
76-79	Front Sway Bar End Link Bushing Kit, 1 1/16" Bar	4-1114
76-79	Front Sway Bar & End Link Bushing Kit, 1 1/8" Bar	4-1115
<b>(Volare)</b>		
76-80	Front Sway Bar & End Link Bushing Kit, 15/16" Bar	4-1112
76-80	Front Sway Bar & End Link Bushing Kit, 1" Bar	4-1113
76-80	Front Sway Bar & End Link Bushing Kit, 1 1/16" Bar	4-1114
76-80	Front Sway Bar & End Link Bushing Kit, 1 1/8" Bar	4-1115
<b>(Diplomat)</b>		
77-79	Front Sway Bar & End Link Bushing Kit, 15/16" Bar	4-1112
77-79	Front Sway Bar & End Link Bushing Kit, 1" Bar	4-1113
77-79	Front Sway Bar & End Link Bushing Kit, 1 1/16" Bar	4-1114
77-79	Front Sway Bar & End Link Bushing Kit, 1 1/8" Bar	4-1115
<b>(Cordoba &amp; Mirada)</b>		
80-83	Front Sway Bar & End Link Bushing Kit, 15/16" Bar	4-1112
80-83	Front Sway Bar & End Link Bushing Kit, 1" Bar	4-1113
80-83	Front Sway Bar & End Link Bushing Kit, 1 1/16" Bar	4-1114
80-83	Front Sway Bar & End Link Bushing Kit, 1 1/8" Bar	4-1115
<b>(Le Baron, Le Baron GTS &amp; Limo)</b>		
77-81	Front Sway Bar & End Link Bushing Kit, 15/16" Bar	4-1112
77-81	Front Sway Bar & End Link Bushing Kit, 1" Bar	4-1113
77-81	Front Sway Bar & End Link Bushing Kit, 1 1/16" Bar	4-1114
77-81	Front Sway Bar & End Link Bushing Kit, 1 1/8" Bar	4-1115
<b>(Fifth Ave., Brougham, Grand Fury &amp; Newport)</b>		
82-89	Front Sway Bar & End Link Bushing Kit, 15/16" Bar	4-1112
82-89	Front Sway Bar & End Link Bushing Kit, 1" Bar	4-1113
82-89	Front Sway Bar & End Link Bushing Kit, 1 1/16" Bar	4-1114
82-89	Front Sway Bar & End Link Bushing Kit, 1 1/8" Bar	4-1115
<b>(Imperial)</b>		
81-83	Front Sway Bar & End Link Bushing Kit, 15/16" Bar	4-1112
81-83	Front Sway Bar & End Link Bushing Kit, 1" Bar	4-1113
81-83	Front Sway Bar & End Link Bushing Kit, 1 1/16" Bar	4-1114
81-83	Front Sway Bar & End Link Bushing Kit, 1 1/8" Bar	4-1115
<b>(Chrysler 300C, Dodge Challenger, Charger, Magnum)</b>		
08-14	Front Sway Bar Bushing Kit, 27mm Bar NEW	4-1140
08-14	Front Sway Bar Bushing Kit, 30mm Bar NEW	4-1141
08-14	Front Sway Bar Bushing Kit, 31mm Bar NEW	4-1142
05-10	Rear Sway Bar Bushing Kit, 11/16" Bar * NEW	4-1139

\* (Includes End Link Bushings)

## SWAY BAR END LINKS, Front

<b>(Dart, Demon, Duster, Swinger, Valiant, Scamp, Barracuda - thru 69)</b>		
65-72	End Link Kit, "A" Body	19-408
73-76	End Link Kit, "A" Body	19-405
<b>(Charger, Coronet, Superbee, Roadrunner, Satellite)</b>		
65-72	End Link Kit, "B" Body	19-408
<b>(Challenger, Barracuda, "Cuda")</b>		
70-74	End Link Kit, "E" Body	19-405

## TIE ROD BOOTS

62-76	Tie Rod Boot Kit, "A" Body All (2)	19-1712
65-79	Tie Rod Boot Kit, "B" Body All (2)	19-1712
70-74	Tie Rod Boot Kit, "E" Body All (2)	19-1712

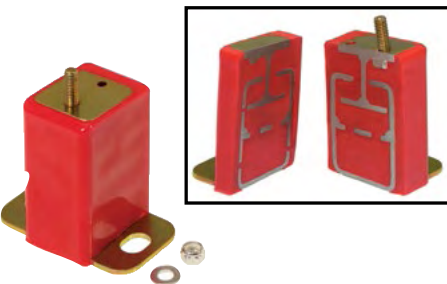

#4-1602 "A" Body  
'67-'72 Transmission  
Mount with Run-Safe  
Metal Polylock

## TORSION BAR CROSS MEMBER

<b>(Charger, Coronet, Superbee, Roadrunner, Satellite)</b>		
73-79	Torsion Bar Cross Member Mount Kit, "B" Body	4-106

## TORSION BAR DUST BOOTS

<b>(Dart, Demon, Duster, Swinger, Valiant, Scamp, Barracuda thru 69)</b>		
62-76	Torsion Bar Dust Boot Kit, "A" Body	4-1701
<b>(Charger, Coronet, Superbee, Roadrunner, Satellite)</b>		
62-79	Torsion Bar Dust Boot Kit, "B" Body	4-1701
<b>(Challenger, Barracuda, "Cuda 70 &amp; Later)</b>		
70-74	Torsion Bar Dust Boot Kit, "E" Body	4-1701

## TRANSMISSION MOUNTS

<b>(Chrysler, Dodge &amp; Plymouth)</b>		
67-72	Transmission Mount Kit "A" Body	4-1602
73+	Transmission Mount Kit "A" Body	4-1603
66-70	Transmission Mount Kit "B" Body	4-1602
71*	Transmission Mount Kit "B" Body	4-1603
72-74	Transmission Mount Kit "B" Body	4-1603
69+	Transmission Mount Kit "C" Body	4-1603
70-74	Transmission Mount Kit "E" Body	4-1603
73+	Transmission Mount Kit, "F, M, J" Bodies	4-1603

\*Changed Mid-Year (Additional Transmission Mount Listings on page 15)

## TOTAL KITS

62-76	"A" Body	4-2001
65-74	"B" Body	4-2001
70-74	"E" Body	4-2001
05-10	Chrysler 300C	4-2010
05-10	Dodge Challenger	4-2010
05-10	Dodge Charger	4-2010
05-08	Dodge Magnum	4-2010

## Chrysler/Dodge/Plymouth/Neon, PT Cruiser

### BUMP STOPS

<b>(PT Cruiser)</b>		
01-06	Rear Bump Stop Kit	4-1301

### COIL SPRING ISOLATORS

<b>(PT Cruiser)</b>		
01-06	Front Coil Spring Isolator Kit, Lower	4-1704
01-06	Rear Coil Spring Isolator Kit, Upper & Lower	4-1705

### CONTROL ARM BUSHINGS, Front

<b>(Neon, SRT-4)</b>		
95-99	Front Control Arm Bushing Kit	4-209
00-05	Front Control Arm Bushing Kit	4-214
<b>(PT Cruiser)</b>		
01-06	Front Control Arm Bushing Kit	4-214

### CONTROL ARM BUSHINGS, Rear

<b>(Neon, SRT-4)</b>		
95-99	Rear Control Arm Bushing Kit	4-301
00-05	Rear Trailing Arm Bushing Kit	4-304
<b>(PT Cruiser)</b>		
01-06	Rear Trailing Arm Bushing Kit	4-302
01-06	Rear Watts Linkage Bushing Kit	4-303



#4-512 Chrysler LX Chassis Billet Aluminum and Urethane  
Motor Mounts Fits: '06-'11 Challenger, Charger, 300c and  
Magnum with 5.7L and 61.L.



## Chrysler Dodge/Plymouth/Neon /PT Cruiser

### END LINK BUSHINGS, Front / Rear

<b>(Neon)</b>			
95-99	Front End Link Kit		4-401
95-99	Rear End Link Kit (Sport Package Only)		4-402
<b>(Neon, SRT-4)</b>			
00-06	Front End Link Kit		4-401
00-06	Rear End Link Kit		19-413
<b>(PT Cruiser)</b>			
01-06	Front End Link Kit		4-401
01-06	Rear End Link Bushing Kit		4-403

### MOTOR MOUNT INSERTS

<b>(Neon-SOHC, DOHC &amp; SRT-4)</b>			
95-99	Engine Mount Insert Kit, Front		4-501
95-99	Engine Mount Insert Kit, Right		4-502
95-99	Transmission Mount Insert Kit, Left		4-503
95-99	All 3 Mounts, Kit		4-1901
95-99	All 3 Mounts, Kit (Softer Street Style)		4-1902
00-06	Upper & Lower Mount Insert Kit (Race)		4-1905
00-06	Upper & Lower Mount Insert Kit (Street)		4-1906

### SHIFTER BUSHINGS

<b>(Neon)</b>			
95-06	Shifter Bushing Kit		4-1605
03-06	SRT-4 Shifter Bushing Kit		4-1606

### STRUT ROD BUSHINGS

<b>(Neon, SRT-4)</b>			
95-99	Rear Strut Rod Bushing Kit		4-1204
00-06	Rear Strut Rod Bushing Kit		4-1206

### SWAY BAR BUSHINGS, Front / Rear

<b>(Neon, SRT-4)</b>			
95-06	Front Sway Bar Bushing Kit, 20mm Bar		4-1118
95-99	Front Sway Bar Bushing Kit, 22mm Bar		4-1119
00-06	Front Sway Bar Bushing Kit, 24mm Bar		4-1120
95-99	Rear Sway B. B. Kit, 16mm Bar (Sport Pkg. only)		4-1111
00-06	Rear Sway Bar Bushing Kit, 12mm Bar		4-1130
00-06	Rear Sway Bar Bushing Kit, 14mm Bar		4-1131
00-06	Rear Sway Bar Bushing Kit, 17mm Bar		4-1137
<b>(PT Cruiser)</b>			
01-06	Front Sway Bar Bushing Kit, 22mm Bar		4-1119
01-06	Front Sway B. B. Kit, 24mm Bar (Tour. Edition only)		4-1120
01-06	Rear Sway Bar Bushing Kit, 18mm		4-1136

### TIE ROD BOOTS

<b>(Neon)</b>			
95-99	Tie Rod Boot Kit (2)		19-1711

### TOTAL KITS

<b>(Neon)</b>			
95-99	Total Kit (Includes Sport Package)		4-2002
00-06	Total Kit (Neon, SRT-4)		4-2007
<b>(PT Cruiser)</b>			
01-06	Total Kit (Includes Touring Edition)		4-2006



#4-2007 Dodge Neon SRT-4 '00-'06 Total Kit

## Dodge/Ram/Dodge Trucks

### BODY MOUNTS

<b>(D100-300, W100-300)</b>			
72-85	Body Mount Kit		4-102
<b>(AD100-150, AW100-150 Ramcharger)</b>			
72-93	Body Mount Kit		4-103
<b>(RAM 1500, 2500, 3500 2 &amp; 4WD)</b>			
94-01	Body Mount Kit (Standard Cab)		4-107
94-01	Body Mount Kit (Extended Cab)		4-108
<b>(D50 2WD)</b>			
79-87	Body Mount Kit		4-104
<b>(Dakota 2WD)</b>			
87-96	Body Mount Kit, Standard Cab		4-105

### COIL SPRING LIFT SPACERS

<b>(Ram 1500, 2500, 3500 4WD)</b>			
94-05	Front Coil Spring Lift Kit, 2" Lift		4-1702
<b>(Ram 1500, 2500, 3500 2WD)</b>			
94-01	Front Coil Spring Lift Kit, 2" Lift		4-1703
<b>(Ram 1500 2WD)</b>			
02-05	Front Coil Spring Lift Kit, 2" Lift		4-1706
<b>(Dakota 2WD)</b>			
87-03	Front Coil Spring Lift Kit, 2" Lift		4-1703

### CONTROL ARM BUSHINGS, Front

<b>(D100-300, AD 100-150-2WD)</b>			
72-93	Control Arm Bushing Kit, w/o Shells		4-203
	Up to 3,600 lb. Axle w/o Heavy Duty Package		
72-93	Control Arm Bushing Kit, w/o Shells		4-204
	Up to 3,800 to 4,000 lb. Axle w Heavy Duty Pk.		
<b>(RAM 1500, 2500, 3500 2WD)</b>			
94-01	Control Arm Bushing Kit, w/o Shells		4-210
<b>(RAM 1500, 2500, 3500 4WD)</b>			
94-98	Control Arm Bushing Kit, w/o Shells		4-211
99-02	Control Arm bushing Kit, w/o Shells		4-217
<b>(RAM 2500, 3500 4WD w/Diesel or V10)</b>			
94-01	Control Arm Bushing Kit, w/o Shells NEW		4-216
<b>(D50 2WD)</b>			
79-90	Control Arm Bushing Kit, Lower Only w/o Shells		4-201
<b>(Dakota 2WD)</b>			
87-96	Control Arm Bushing Kit, Uppers w/o Shells		4-208
97-03	Control Arm Bushing Kit		4-212
	(Upper w/o Shells, Lower w/ Shells)		
<b>(Dakota 4WD)</b>			
97-03	Control Arm Bushing Kit, w/o Shells		4-213

### COIL SPRING LIFT SPACERS

<b>(Ram 1500, 2500, 3500 4WD)</b>			
94-05	Front Coil Spring Lift Kit, 2" Lift		4-1702
<b>(Ram 1500, 2500, 3500 2WD)</b>			
94-01	Front Coil Spring Lift Kit, 2" Lift		4-1703
<b>(Ram 1500 2WD)</b>			
02-05	Front Coil Spring Lift Kit, 2" Lift		4-1706
<b>(Dakota 2WD)</b>			
87-03	Front Coil Spring Lift Kit, 2" Lift		4-1703

#4-1702-BL Ram 1500, 2500, 3500 4WD '94-'05 Front Coil Spring 2" Lift Kit



#4-107 Body Mount Kit  
RAM 1500, 2500, 3500 2 & 4WD

### CONTROL ARM BUSHINGS, Front

<b>(D100-300, AD 100-150-2WD)</b>		
72-93	Control Arm Bushing Kit, w/o Shells Up to 3,600 lb. Axle w/o Heavy Duty Package	4-203
72-93	Control Arm Bushing Kit, w/o Shells Up to 3,800 to 4,000 lb. Axle w Heavy Duty Pk.	4-204
<b>(RAM 1500, 2500, 3500 2WD)</b>		
94-01	Control Arm Bushing Kit, w/o Shells	4-210
<b>(RAM 1500, 2500, 3500 4WD)</b>		
94-98	Control Arm Bushing Kit, w/o Shells	4-211
99-02	Control Arm bushing Kit, w/o Shells	4-217
<b>(RAM 2500, 3500 4WD w/Diesel or V10)</b>		
94-01	Control Arm Bushing Kit, w/o Shells NEW	4-216
<b>(D50 2WD)</b>		
79-90	Control Arm Bushing Kit, Lower Only w/o Shells	4-201
<b>(Dakota 2WD)</b>		
87-96	Control Arm Bushing Kit, Uppers w/o Shells	4-208
97-03	Control Arm Bushing Kit (Upper w/o Shells, Lower w/ Shells)	4-212
<b>(Dakota 4WD)</b>		
97-03	Control Arm Bushing Kit, w/o Shells	4-213

### MOTOR MOUNTS

Various (See Application Charts on Page 17)

### SPRING & SHACKLE BUSHINGS, Front / Rear

<b>(D100-300, AD 100-150 &amp; AW100-150-2 &amp; 4WD W100-300)</b>		
72-93	Spring Eye Bushing Kit (Front or Rear 4WD/ Rear 2WD, w/1.000" ID Spring Eye)	4-1005
<b>(Ram 1500-3500 2WD &amp; 4WD)</b>		
94-99	Rear Spring Eye & Shackle Bushing Kit (w/2 1/2" O/D Main Eye & 2 1/2" Wide Spring)	4-1008
<b>(D50 2WD)</b>		
79-90	Rear Spring Eye & Shackle Bushing Kit	4-1006
<b>(Dakota 2WD &amp; 4WD)</b>		
87-96	Rear Spring Eye & Shackle Bushing Kit	4-1007

### STEERING RACK BUSHINGS

<b>(Ram 1500, 2500, 3500, 2WD)</b>		
02-07	Steering Rack Bushing Kit	4-701

### STRUT ARM BUSHINGS

<b>(D100-300, AD 100-150, 2WD)</b>		
72-93	Strut Arm Bushing Kit	4-1203
<b>(D50 2WD)</b>		
79-93	Strut Arm Bushing Kit	4-1201

### SWAY BAR BUSHINGS, Front / Rear

<b>(D50 2WD &amp; 4WD)</b>		
79-90	Front Sway Bar Bushing & End Link Kit, 7/8" Bar	4-1101
<b>(Ram 1500, 2500, 3500 2WD &amp; 4WD)</b>		
94-01	Front Sway Bar & End Link Bushing Kit, 30mm Bar	4-1102
94-01	Front Sway Bar & End Link Bushing Kit, 32mm Bar	4-1103
94-05	Front Sway Bar & End Link Bushing Kit, 34mm Bar	4-1138
<b>(Dakota 2WD)</b>		
87-96	Front Sway Bar Bushing & End Link Kit, 28mm Bar	4-1110
97-01	Front Sway Bar & End Link Bushing Kit, 28mm Bar	4-1117
97-01	Front Sway Bar & End Link Bushing Kit, 30mm Bar	4-1102
<b>(Dakota 4WD)</b>		
97-99	Front Sway Bar & End Link Bushing Kit, 28mm Bar	4-1132
97-99	Front Sway Bar & End Link Bushing Kit, 33mm Bar	4-1133
00-01	Front Sway Bar & End Link Bushing Kit, 33mm Bar	4-1134
00-01	Front Sway Bar & End Link Bushing Kit, 35mm Bar	4-1135
<b>(Dakota 2WD &amp; 4WD)</b>		
97-98	Rear Sway Bar & End Link Bushing Kit, 15mm Bar	4-1125
99-01	Rear Sway Bar & End Link Bushing Kit, 22mm Bar	4-1126
<b>(Durango 2WD)</b>		
99-01	Front Sway Bar & End Link Bushing Kit, 28mm Bar	4-1117
99-01	Front Sway Bar & End Link Bushing Kit, 30mm Bar	4-1102
<b>(Durango 2WD &amp; 4WD)</b>		
98-01	Rear Sway Bar & End Link Bushing Kit, 18mm Bar	4-1127
98-01	Rear Sway Bar & End Link Bushing Kit, 22mm Bar	4-1128
98-01	Rear Sway Bar & End Link Bushing Kit, 16mm Bar	4-1129
<b>(Durango 4WD)</b>		
98-99	Front Sway Bar & End Link Bushing Kit, 28mm Bar	4-1132
98-99	Front Sway Bar & End Link Bushing Kit, 33mm Bar	4-1133
<b>(Durango 4WD)</b>		
00-01	Front Sway Bar & End Link Bushing Kit, 33mm Bar	4-1134
00-01	Front Sway Bar & End Link Bushing Kit, 35mm Bar	4-1135

### TIE ROD BOOTS

<b>(D50-2WD)</b>		
79-90	Tie Rod Boot Kit (2)	19-1712
<b>(Dakota 2WD)</b>		
97-03	Tie Rod Boot Kit (2)	19-1714
<b>(D100-300, Ramcharger (AD 100-150)-2WD)</b>		
69-93	Tie Rod Boot Kit (2)	19-1712
<b>(W100-300, Ramcharger (AW 100-150)-4WD)</b>		
69-93	Tie Rod Boot Kit (2)	19-1712
<b>(Van B100-300)</b>		
70-93	Tie Rod Boot Kit (2)	19-1712

### TRACK ARM BUSHINGS

<b>(RAM 1500, 2500, 3500 4WD)</b>		
94-01	Front Track Arm Bushing Kit	4-1205

### TRANSMISSION MOUNTS

<b>(D100-300 2WD, Ramcharger 100 2WD)</b>		
72-87	Transmission Mount Kit, 225, 318, 360 C.I.E.	4-1601
<b>(W100-300 4WD, Ramcharger 100 4WD)</b>		
72-78	Transmission Mount Kit, 225 C.I.E.	4-1601
<b>(Van B100-300 2WD)</b>		
69-78	Trans. Mount Kit, 198, 225, 318, 360, 400 C.I.E.	4-1601
79-81	Trans. Mount Kit, 318, 360, 400, 440 C.I.E.	4-1601
82-87	Trans. Mount Kit, 198, 225, 318, 360, 400, 440 C.I.E.	4-1601

(Additional Transmission Mount Listings on page 17)

### TOTAL KITS

72-85	Total Kit (W100-300-4WD)	4-2016
72-93	Total Kit (Ramcharger-4WD)	4-2017
87-96	Total Kit (Dakota 2WD)	4-2003
94-01	Total Kit (Ram 1500, 2500, 3500, All 2WD)	4-2004
94-01	Total Kit (Ram 1500, 2500, 3500, All 4WD)	4-2005
94-01	Total Kit (Ram 2500, 3500 4WD Diesel, V10) NEW	4-2008



#4-203-BL '72-'93 (D100-300, AD 100-150-2WD)  
Control Arm Bushing Kit, w/o Shells



#4-2005 Ram 1500, 2500, 3500  
All, 4WD '94-'01 Total Kit

**Ford Focus**

**BUMP STOPS, Front / Rear**

00-06	Front Strut Bump Stop Kit	6-1302
00-06	Rear Bump Stop Kit	6-1301

**COIL SPRING ISOLATORS**

00-06	Rear Coil Spring Isolator Kit	6-1705
-------	-------------------------------	--------

**CONTROL ARM BUSHINGS, Front / Rear**

00-06	Front Control Arm Bushing Kit	6-214
00-06	Rear Control Arm Bushing Kit	6-307
00-06	Rear Trailing Arm Bushing Kit	6-308

**MOTOR MOUNT BUSHINGS & INSERTS**

00-06	Motor Mount Bushing Kit, Front Lower	6-502
12-13	Motor Mount Insert, Rear	6-506

**SWAY BAR BUSHINGS, Front / Rear**

00-06	Front Sway Bar Bushing Kit, 21mm Bar	6-1152
00-06	Rear Sway Bar Bushing Kit, 20mm Bar	6-1153

**TOTAL KITS**

00-06	Total Kit	6-2026
-------	-----------	--------



**#6-220 Mustang '05-'13 Front Control Arm Bushing Kit-Rear Location w/Brackets**



**#6-312-BL Mustang '05-'10 Rear Upper & Lower Control Arm Bushing Kit**

**Ford Mustang**

**BALL JOINT BOOTS**

79-93	Ball Joint Boot Kits (2)	19-1723
94-04	Ball Joint Boot Kits (2)	19-1724

**BUMP STOPS**

64-73	Front Bump Stop Kit (Black)	6-1303-BL
-------	-----------------------------	-----------

**CONTROL ARM BUSHINGS, Front**

64-66	Control Arm Bushing Kit, w/o Shells (Lower Insert)	6-201
67-73	Control Arm Bushing Kit, w/o Shells (w/1.4375" O.D. Lower Insert)	6-202
67-73	Control Arm Bushing Kit, w/o Shells (w/1.5625" O.D. Lower Insert)	6-203
74-78	Control Arm Bushing Kit, w/o Shells	6-204
79-82	Control Arm Bushing Kit, w/o Shells (w/ Heavy Duty Suspension)	6-206
79-93	Control Arm Bushing Kit, w/o Shells (Except Heavy Duty Suspension)	6-205
79-93	Control Arm Bushing Kit, w/ Shells (Except Heavy Duty Suspension)	6-209
84-86	Control Arm Bushing Kit, w/o Shells (SVO)	6-208
94-04	Front C-Arm Bushings w/o Shells (w/Non-Hydro Lower Bushing)	6-207
96-04	Front "Hydro" C-Arm Bushing Kit w/o Shells	6-217
05-14	Front Control Arm Bushing Kit (Front Bushings Only)	6-218
05-13	Front Control Arm Bushing Kit w/Brackets (Rear Bushings Only)	6-220

**CONTROL ARM BUSHINGS, Rear**

79-93	Control Arm Bushing Kit, w/o Shells (w/ Round Bushing)	6-301
84-86	Control Arm Bushing Kit, w/o Shells (Mustang SVO)	6-303
79-98	Control Arm Bushing Kit, w/o Shells (Front Lower Oval Bushings)	6-302
79-03	Control Arm Bushing Axle Housing Kit (Hard Durometer, w/o Shells)	6-309
99-04	Control Arm Bushing Kit, w/o Shells (Front Lower Oval Bushing)	6-306
99-04	Cobra I.R.S. C-Arm Bushing Kit w/o Shells	6-311
05-14	Control Arm Bushing Kit, Upper & Lower	6-312
05-14	Control Arm Bushing Kit, Lower Only	6-313
05-14	Control Arm Bushing Kit, Upper Only	6-314
15-17	Rear Control Arm Bushing Kit	6-317

**DIFFERENTIAL BUSHINGS**

99-04	Cobra I.R.S. Differential Bushing Kit, Front	6-1609
99-04	Cobra I.R.S. Differential Bushing Kit, Rear	6-1610
05-10	Differential Bushing Kit	6-315

**MOTOR MOUNTS**

Various (See Application Charts on Page 17)

**SHIFTER BUSHINGS** (Does not fit Shelby Models)

05-10	Shifter Bushing Kit	6-1611
11-14	Shifter Bushing only (fits OEM or our billet bracket)	6-1612
11-14	Shifter Bushings With Billet Bracket Kit	6-1613
11-14	Shifter Bracket Only	
	(works with our bushing or OEM)	6-1614

**SPRING ISOLATORS, Front / Rear**

64-73	Front Spring Isolator, Uppers Only	6-1704
79-82	Front Coil Spring Isolators, Uppers Only	6-1708
79-99	Rear Spring Isolators, Upper & Lower	6-1701
83-99	Front Spring Isolators, Upper & Lower	6-1703
99-04	Cobra Ind. Rear Spring Isolators, Lower Only	6-1709

**SPRING PERCHES, Front**

64-73	Front Coil Spring Perch Pair, Lower	6-1702
-------	-------------------------------------	--------

**SPRING & SHACKLE, OEM & HD, Rear**

64-73	Spring Eye & Shackle Bushing Kit (1/2" Shackle Bolts)	6-1051
64-66	Spring Eye & Shackle Bushing Kit (9/16" Shackle Bolts)	6-1052
64-73	Spring Eye & Heavy Duty Shackle Kit**	6-1053
64-73	Rear Heavy Duty Shackle Kit Only*	6-1054

\*Includes rear only eye bushings, shackle bushings, zinc plated heavy duty steel shackles, bolts and locknuts.  
 \*\*Includes both spring eye bushings, shackle bushings, zinc plated heavy duty steel shackles, bolts and locknuts.

## Mustang Continued...

### STEERING

64-70	Power Steering Ram Bushing Kit	6-705
74-78	Rack & Pinion Bushing Kit	6-701
79-9/84	Rack & Pinion Bushing Kit	6-702
10/84-02	Rack & Pinion Bushing Kit	6-703
10/84-02	Rack & Pinion Bushing Kit (Offset Style)* *(For Lowered cars.)	6-704

### STRUT ARM BUSHINGS

64-66	Strut Arm Bushing Kit	6-1204
67-73	Strut Arm Bushing Kit	6-1205
74-78	Strut Arm Bushing Kit	6-1206

### STRUT TOWER BUSHINGS

83-04	McPherson Strut Tower Bushing Kit	6-1213
-------	-----------------------------------	--------

### SUBFRAME MOUNTS

79-98	IRS Subframe Bushing Kit	6-111
99-04	Cobra/Mustang IRS Subframe Bushing Kit	6-112

### SWAY BAR BUSHINGS, Front

99-04	Sway Bar Bushings	(See Page 10 For S/B Bushing Listings)
79-04	Sway Bar Bushing Kit, 7/8" Bar	6-1120
79-04	Sway Bar Bushing Kit, 15/16" Bar	6-1121
79-04	Sway Bar Bushing Kit, 1" Bar	6-1122
79-04	Sway Bar Bushing Kit, 1-1/16" Bar	6-1123
79-04	Sway Bar Bushing Kit, 1-1/8" Bar	6-1124
79-04	Sway Bar Bushing Kit, 1-1/4" Bar	6-1125
79-04	Sway Bar Bushing Kit, 1-5/16" Bar	6-1126
79-04	Sway Bar Bushing Kit, 1-3/8" Bar	6-1133
79-04	Sway Bar Bushing Kit, 25mm Bar	6-1134
79-04	Sway Bar Bushing Kit, 27mm Bar	6-1135
79-04	Sway Bar Bushing Kit, 28mm Bar	6-1155
79-04	Sway Bar Bushing Kit, 29mm Bar	6-1136
79-04	Sway Bar Bushing Kit, 30mm Bar	6-1137
04-06	Sway Bar Bushing Kit, 25mm Bar (Rough Only)	6-1158
05-06	Sway Bar Bushing Kit, 28.6mm Bar	6-1164
05-10	Sway Bar Bushing Kit, 34mm Bar	6-1161
15-18	Sway Bar Bushing Kit, 32mm Bar	6-1172

### SWAY BAR BUSHINGS & END LINKS, Rear

99-04	Sway Bar Bushing Kit, 25mm Bar (For Cobra Models)	6-1157
05-06	Sway Bar Bushing Kit, w/End Links, 18mm Bar (For Convertible Models w/V-6 Only)	6-1163
05-10	Sway Bar Bushing Kit, w/End Links, 20mm Bar	6-1162

### SWAY BAR END LINKS, Front

64-66	End Link Kit	19-405
67-73	End Link Kit	19-408
79-93	End Link Kit	19-417
84-86	Sway Bar End Link Kit (For Mustang SVO)	19-417
79-04	Mustang O.E. Style Bushing Kit (8) (End Link Bushings Only)	19-431
94-04	End Link Kit	19-416



#6-1162-BL Mustang '05-10 Rear Sway Bar Bushing Kit

### TIE ROD BOOTS

64-66	Tie Rod Boot Kit (2)	19-1711
65-73	Tie Rod Boot Kit (2)	19-1725
67-04	Tie Rod Boot Kit (2)	19-1712

### TRACK BAR, Rear

05-13	Track Bar Bushing Kit	6-1219
-------	-----------------------	--------

### TRANSMISSION MOUNTS

65-73	Transmission Mount Kit, (For V8 Vehicles)	6-1605
79-84	Trans. Mount Kit, (For 6 Cyl. w/ Auto. Vehicles)	6-1604
79-93	Trans. Crossmember to Frame Bushing Kit	6-1603
79-95	Trans. Mount Kit, (For GT w/Manual Trans.)	6-1604
79-98	Trans. Mount Kit, GT (Automatic)	6-1604
96-98	Trans. Mount Kit, Cobra (Manual) (Does not fit 96-98 GT manual)	6-1604
11/95-98	6 cyl. Auto. & Manual Transmission	6-1604
99-04	Trans. Mount & X-Member Combo Kit	6-1606
99-04	Trans. X-member (Requires 6-1605)	6-1607
79-98	Conversion Trans. Mount Kit	6-1608
<b>(Tremec T56 6 spd. Requires Customer Fabrication)</b>		
14-17	Trans. Mount Custom Billet Kit	6-1615
14-17	Trans. Mount Insert Only Kit	6-1616

### TOTAL KITS

65-66	Total Kit (w/o Trans. Mount)	6-2004
65-66	Total Kit (w/V8, w/Trans. Mount)	6-2024
67-73	Total Kit (w/o Trans. Mount)	6-2001
79-82	Total Kit (w/o Trans. Mount)	6-2029
79-82	Total Kit (V8 Auto & Man., w/ Trans. Mount)*	6-2030
83-84	Total Kit (w/o Trans. Mount)	6-2031
83-84	Total Kit (V8 Auto & Man., w/ Trans. Mount)*	6-2032
85-93	Total Kit (w/o Trans. Mount)	6-2002
85-93	Total Kit (w/V8, w/Trans. Mount)	6-2005
94-98	Total Kit (w/o Trans. Mount)	6-2003
94-98	Total Kit (w/V8, w/Trans. Mount)**	6-2006
99-04	Total Kit (Except Cobra) (w/o Trans. Mount)	6-2025
99-04	Total Kit (Cobra, w/o Trans. Mount)	6-2033
05-06	Total Kit (GT, w/o Trans. Mount)	6-2034

\* (6 Cyl. w/ Auto.) \*\* (Does Not Fit 96-98 GT Manual Trans.)

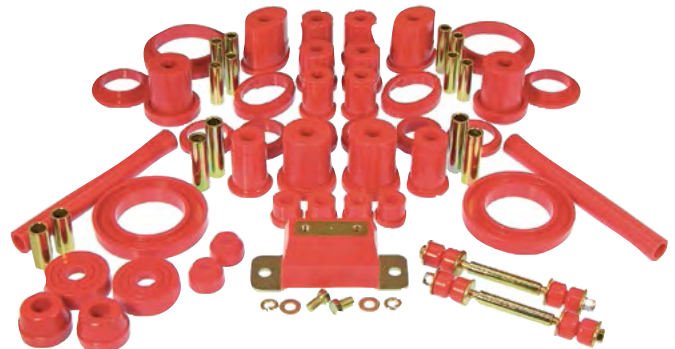

#6-2006 Mustang V8 '94-'98 Total Kit



6-1616 Insert shown mounted in OEM transmission mount housing

#6-1616 '11-'17 Mustang Trans. Mount Insert Only Kit



## Ford Compact, Mid-Size & Full Size

### CONTROL ARM BUSHINGS, Front

**(Crown Victoria w/Police, Tow & Taxi Package)**

92-94	Front Control Arm Bushing Kit w/o Shells	6-215
95-97	Front Control Arm Bushing Kit w/o Shells	6-216

**(Fairlane, Grand Torino, Torino, Elite & Ranchero)**

67-71	Front Control Arm Bushing Kit w/o Shells (Lower Insert 1.4375" O.D.)	6-202
67-71	Front Control Arm Bushing Kit w/o Shells (Lower Insert 1.5625" O.D.)	6-203

**(Granada)**

75-80	Front Control Arm Bushing Kit w/o Shells (Lower insert 1.4375" O.D.)	6-202
75-80	Front Control Arm Bushing Kit w/o Shells (Lower insert 1.5625" O.D.)	6-203

**(Fairlane, Grand Torino, Torino, Elite, Ranchero after 3/15/72)**

72-79	Front Control Arm Bushing Kit w/o Shells	6-210
72-78	Front Control Arm Bushing Kit w/o Shells	6-210

### MOTOR MOUNTS

Various (See Application Chart on Page 14-19)

### STEERING

**(Fairlane, Grand Torino, Torino, Elite)**

65-71	Power Steering Ram Bushing Kit	6-705
70-72	Power Steering Ram Bushing Kit	6-705

### STRUT ARM BUSHINGS

**(Falcon/Ranchero)**

60-66	Strut Arm Bushing Kit	6-1204
-------	-----------------------	--------

**(Fairlane)**

62-66	Strut Arm Bushing Kit	6-1204
67-71	Strut Arm Bushing Kit	6-1205

**(Fairlane, Grand Torino, Torino, Elite, Ranchero after 3/15/72)**

72-79	Strut Arm Bushing Kit	6-1216
-------	-----------------------	--------

**(Full Size, Galaxie, Crown Victoria, Custom, LTD thru 82)**

65-78	Strut Arm Bushing Kit	6-1216
-------	-----------------------	--------

**(Granada)**

75-80	Strut Arm Bushing Kit	6-1205
-------	-----------------------	--------

### STRUT ARM BUSHINGS (Continued)

**(Pinto)**

74-80	Strut Arm Bushing Kit	6-1206
-------	-----------------------	--------

**(Taurus)**

86-95	Strut Arm Bushing Kit (Front)	6-1214
86-95	Strut Arm Bushing Kit (Rear)	6-1215

### SWAY BAR BUSHINGS, Front

**(Escort)**

90-96	Sway Bar Bushing Kit, 3/4" Bar	6-1149
90-96	Sway Bar Bushing Kit, 15/16" Bar	6-1150

**(Taurus)**

86-95	Sway Bar Bushings	(See Page 10 For S/B Bushing Listings)
-------	-------------------	--

### SWAY BAR BUSHINGS & END LINKS, Rear

**(Escort)**

90-96	Sway Bar Bushing Kit, 3/4" Bar	6-1149
-------	--------------------------------	--------

**(Taurus)**

86-95	Sway Bar & End Link Bushing Kit, 20mm Bar	6-1139
86-95	Sway Bar & End Link Bushing Kit, 1" Bar	6-1140
86-95	Sway Bar & End Link Bushing Kit, 1-1/16" Bar	6-1141
86-95	Sway Bar & End Link Bushing Kit, 1-1/8" Bar	6-1142

### SWAY BAR END LINKS, Front / Rear

**(AC Cobra)**

62-67	End Link Kit	19-405
-------	--------------	--------

**(Escort)**

90-96	End Link Kit (Front)	4-401
90-96	End Link Kit (Rear)	6-401

**(Fairmont)**

78-82	End Link Kit	19-417
-------	--------------	--------

**(Fairlane, Grand Torino, Elite &, Ranchero after 3/15/72)**

67-71	End Link Kit	19-405
72-79	End Link Kit	19-409

**(Galaxie, Crown Victoria & Custom, LTD thru 82)**

72-78	End Link Kit	19-409
83-88	End Link Kit (LTD w/o Tow Pkg)	19-417

**(Granada)**

75-80	End Link Kit	19-405
81-82	End Link Kit	19-417

**(Maverick)**

70-77	End Link Kit	19-408
-------	--------------	--------

### TIE ROD BOOTS

62-95	Tie Rod Boot Kit (2)	19-1712
-------	----------------------	---------

### TRANSMISSION MOUNTS

65-68	Transmission Mount (Fairlane)	6-1605
62-70	Transmission Mount (Falcon)	6-1605
75-80	Transmission Mount (Granada)	6-1605
65-77	Transmission Mount (Maverick)	6-1605
68-76	Transmission Mount (Torino)	6-1605



**#6-1605 Transmission Mount with Metal Polylock**



**#6-505-BL Billet Aluminum and Urethane Bullet Motor Mount Kit for '05-'17 Mustangs with 4.0L & 4.6L**



**#6-1606-BL Trans Mount With/ X Member '99-'04**

## Ford GT

### MOTOR AND TRANSMISSION MOUNT

(Ford GT)			
04-06	Two Motor Mounts Sets & Transmission Top Mount	6-1906	

## Ford Thunderbird

### CONTROL ARM BUSHINGS, Front

80-86	Control Arm Bushing Kit, w/ Shells (Except Heavy Duty Suspension)	6-209	
80-86	Control Arm Bushing Kit, w/o Shells (Except Heavy Duty Suspension)	6-205	
80-86	Control Arm Bushing Kit, w/o Shells (w/ Heavy Duty Suspension)	6-206	
87-88	Control Arm Bushing Kit, w/o Shells	6-211	

### CONTROL ARM BUSHINGS, Rear

80-88	Control Arm Bushing Kit, w/o Shells (w/ Round Bushings)	6-301	
80-88	Control Arm Bushing Kit, w/o Shells (Front Lower Oval Bushing)	6-302	

### MOTOR MOUNTS

80-85	Motor Mount Pair Kit (w/5.0 Engine)	6-501	
-------	-------------------------------------	-------	--

### STEERING

80-9/84	Rack & Pinion Bushing Kit	6-702	
10/84-88	Rack & Pinion Bushing Kit	6-703	

### STRUT ARM BUSHINGS

72-79	Front Strut Arm Bushing Kit	6-1216	
-------	-----------------------------	--------	--

### SWAY BAR BUSHINGS, Front

80-88	Sway Bar Bushing Kit, 7/8" Bar	6-1120	
80-88	Sway Bar Bushing Kit, 15/16" Bar	6-1121	
80-88	Sway Bar Bushing Kit, 1" Bar	6-1122	
80-88	Sway Bar Bushing Kit, 1-1/16" Bar	6-1123	
80-88	Sway Bar Bushing Kit, 1-1/8" Bar	6-1124	
80-88	Sway Bar Bushing Kit, 1-1/4" Bar	6-1125	
80-88	Sway Bar Bushing Kit, 1-5/16" Bar	6-1126	

### SWAY BAR BUSHINGS & END LINKS, Rear

89-97	Sway Bar & End Link Bushing Kit, 25mm Bar	6-1147	
89-97	Sway Bar & End Link Bushing Kit, 27mm Bar	6-1148	

### SWAY BAR END LINKS, Front

72-79	End Link Kit	19-409	
80-82	End Link Kit	19-417	
83-88	End Link Kit	19-412	

### TIE ROD BOOTS

72-97	Tie Rod Boot Kit (2)	19-1712	
-------	----------------------	---------	--

### TRANSMISSION MOUNTS

80-84	Transmission Mount Kit, 6 cyl. w/Auto Trans.	6-1604	
80-88	Transmission Mount Kit, V-8 All	6-1604	



#6-1148 Thunderbird '89-'97 Rear Sway Bar Bushing Kit

## Ford Full Size Trucks

### AXLE PIVOT BUSHINGS

<b>(E250, E350 2WD Van)</b>			
92-06	Axle Pivot Bushing Kit		6-603
<b>(Explorer 2WD)</b>			
91-94	Axle Pivot Bushing Kit		6-605
<b>(Explorer 4WD)</b>			
91-94	Axle Pivot Bushing Kit		6-601
<b>(F100, F150 2WD)</b>			
65-79	Axle Pivot Bushing Kit (With Twin I-Beam)		6-604
80-7/81	Axle Pivot Bushing Kit (Cast Axle)		6-603
8/81-5/83	Axle Pivot Bushing Kit (Stamped Axle)		6-601
6/83-86	Axle Pivot Bushing Kit (Cast Axle)		6-603
87-96	Axle Pivot Bushing Kit (Cast Axle)		6-605
<b>(F250, F350 2WD)</b>			
65-79	Axle Pivot Bushing Kit, F250 (w/Twin I-Beam, Exc. Heavy Duty)		6-604
75-79	Axle Pivot Bushing Kit, F350 (w/Twin I-Beam)		6-604
80-86	Axle Pivot Bushing Kit, F250 & F350		6-603
87-89	Axle Pivot Bushing Kit, F250 & F350		6-605
90-98	Axle Pivot Bushing Kit, F250 & F350		6-603
<b>(F100, F150, F250 &amp; Bronco- 4WD)</b>			
80-96	Axle Pivot Bushing Kit		6-601
<b>(F350 4WD)</b>			
80-87	Axle Pivot Bushing Kit (All Kits Include Inserts & Inner Sleeves)		6-601

### BODY & CAB MOUNTS, 2WD & 4WD

<b>(Bronco 2WD &amp; 4WD)</b>			
66-77	16 Bushing Kit		6-101
66-77	Hardware Kit For #6-101		6-102
78-79	20 Bushing Kit		6-103
80-96	20 Bushing Kit		6-107
<b>(Explorer Sport Trac)</b>			
01-05	Bushing Kit NEW		6-116
<b>(F100, F150, F250, F350 2WD &amp; 4WD)</b>			
66-79	12 Bushing Kit (4WD)		6-105
66-79	12 Bushing Kit (2WD)		6-110
80-96	12 Bushing Kit (2WD & 4WD)		6-108
<b>(F150, F250 Light Duty 2WD &amp; 4WD)</b>			
97-03	Body Mount Kit (All Models)		6-115

### C-BUSHINGS, RADIUS ARM BUSHINGS, TRACK ARM BUSHINGS

<b>(E250, E350 2WD Van)</b>			
92-06	Front Strut Arm Bushing Kit		6-1207
<b>(F100, F150, Bronco 2WD &amp; 4WD)</b>			
66-79	C-Bush. Only, 4 Pc. Kit- 2" Offset (Stock to 2" Lift)		6-1201
66-79	C-Bush. Only, 4 Pc. Kit- 4" Offset (2" to 4" Lift)		6-1202
66-79	C-Bush. Only, 4 Pc. Kit- 7" Offset (4" or More)		6-1203
66-79	Radius Arm Bushing Kit		6-1207
80-92	Radius Arm Bushing Kit		6-1209
80-1/92	Radius Arm Bushing Kit (Bronco)		6-1209
2/92-96	Radius Arm Bushing Kit (Bronco)		6-1210



#6-107-BL Bronco '80-'96 Body Mount Kit

## FORD full sized trucks continued...

### C-BUSHINGS, RADIUS ARM BUSHINGS, TRACK ARM BUSHINGS

<b>(F100, F150, Bronco 2WD &amp; 4WD)</b>			
93-96	Radius Arm Bushing Kit	6-1210	
66-79	Track Arm Bushing Kit - Round Type	6-1208	
76-77	Track Arm Bushing Kit - Oval Type (Bronco)	6-1211	
66-79	Complete 14-Piece Bushing Kit - 2" Offset	6-1901	
66-79	Complete 14-Piece Bushing Kit - 4" Offset	6-1902	
66-79	Complete 14-Piece Bushing Kit - 7" Offset	6-1903	
<b>(F250, F350, F450 2WD &amp; 4WD)</b>			
65-79	Radius Arm Bushing Kit (F250, 2WD Only)	6-1207	
80-92	Radius Arm Bushing Kit (2WD Only)	6-1209	
93-98	Radius Arm Bushing Kit (2WD Only)	6-1210	
85-98	Track Arm Bushing Kit (4WD Only) (F350)	6-1212	
85-98	Track Arm Bushing Kit (2WD Only) (F350, F450 Super Duty / Solid Axle)	6-1212	
<b>(F250, F350 Super Duty 4WD)</b>			
99	Front Track Bar Bushing Kit	6-1217	
00-03	Front Track Bar Bushing Kit	6-1218	
<b>(Excursion 4WD)</b>			
00-05	Front Track Bar Bushing Kit, (w/15.5mm Bolt)	6-1217	
00-05	Front Track Bar Bushing Kit, (w/21.5mm Bolt)	6-1218	
<b>(Explorer 2WD &amp; 4WD)</b>			
83-94	Strut Arm Bushing Kit	6-1210	

### COIL SPRING LIFT SPACERS

<b>(F150 2WD)</b>			
97-03	Front Coil Spring Lift Kit, 1.5" Lift	6-1707	
<b>(F150 2WD &amp; 4WD)</b>			
04-05	Front Coil Spring Lift Kit, 2.5" Lift	6-1710	
09-Later	Front Coil Spring Lift Kit, 2" Lift	6-1713	
<b>(Expedition 2WD &amp; 4WD)</b>			
03-04	Front Coil Spring Lift Kit, 2.5" Lift	6-1710	
<b>(F250, F350, Bronco, 2WD)</b>			
99-09	F250 & F350 Front Coil Spring Lift Kit, 2" Lift	6-1711	
83-87	Bronco Front Coil Spring Lift Kit, 2" Lift	6-1711	
<b>(F250 Suprt Duty 4WD)</b>			
05-09	F250 Super Dwy Front Coil Spring Lift Kit, 2.5" Lift	6-1712	

### CONTROL ARM BUSHINGS, Front

95-01	Control Arm Bushing Kit (Explorer 2 & 4WD)	6-213	
97-02	Control Arm Bushing Kit (Expedition 2WD)	6-212	
97-03	Control Arm Bushing Kit (F150 2WD)	6-212	
97-99	Control Arm Bushing Kit (F250 2WD Light Duty)	6-212	
97-03	Control Arm Bushing Kit (F150, F250 4WD Light Duty)	6-219	
99-03	Control Arm Bushing Kit (F150 Lightning)	6-212	
98-03	Control Arm Bushing Kit (Navigator 2WD)	6-212	
04-06	Control Arm Bushing Kit (F150 2 & 4WD)	6-221	

**#6-221 F150 2 & 4WD '04-'06 Front Control Arm Bushing Kit**



**#6-1902-BL F100, F150 '66-'79 2WD Complete 14-Piece Bushing Kit - 4° Offset**

### SPRING & SHACKLE BUSHINGS, Front

<b>(F250 4WD)</b>			
67-77	Spring Eye & Shackle Bushing Kit w/1-1/4" OD Main Eye	6-1009	
67-79	Frame Shackle Bushing Kit	6-801	
73-77	Spring Eye & Shackle Bushing Kit w/1-1/2" OD Main Eye Before Serial #Y20.001 (Does Not Fit Crew Cab)	6-1010	
77-79	Spring Eye & Shackle Bushing Kit From Serial #Y20.001 (Does Not Fit Crew Cab)	6-1011	
<b>(F250 4WD)</b>			
99-04	Spring & Shackle Bushing Kit	6-1025	
<b>(F250, F350 4WD)</b>			
80-98	Spring Eye & Shackle Bushing Kit w/2" OD Spring Eye	6-1012	
80-98	Frame Shackle Bushing Kit	6-802	
<b>(F350 Super Duty 2WD)</b>			
80-98	Spring Eye & Shackle Bushing Kit	6-1013	
<b>(F350 Super Duty 2WD)</b>			
80-98	Frame Shackle Bushing Kit	6-802	
<b>(F450 2WD)</b>			
92-97	Spring & Shackle Bushing Kit	6-1028	

### SPRING & SHACKLE BUSHINGS, Rear 2WD

<b>(F100, F150 2WD)</b>			
57-72	Spring Eye & Shackle Bushing Kit	6-1001	
57-72	Frame Shackle Bushing Kit	6-803	
68-72	Spring Eye & Shackle Bushing Kit	6-1023	
68-72	Shackle Bushing Kit	6-812	
73-79	Spring Eye & Shackle Bushing Kit	6-1002	
73-79	Frame Shackle Bushing Kit	6-807	
80-81	Spring Eye & Shackle Bushing Kit (F100 Only)	6-1003	
80-81	Frame Shackle Bushing Kit (F100)	6-807	
80-81	Spring Eye & Shackle Bushing Kit (F150 Only)	6-1002	
80-81	Frame Shackle Bushing Kit (F150 Only)	6-807	
82-96	Spring Eye & Shackle Bushing Kit	6-1017	
82-96	Frame Shackle Bushing Kit	6-805	
97-04	Spring Eye & Shackle Bushing Kit	6-1024	
04-06	Spring Eye & Shackle Bushing Kit	6-1055	
<b>(F250 2WD- Except Crew Cab)</b>			
68-72	Spring Eye & Shackle Bushing Kit	6-1022	
68-72	Shackle Bushing Kit	6-812	
73-79	Spring Eye & Shackle Bushing Kit	6-1004	
73-79	Frame Shackle Bushing Kit	6-804	
97-04	Spring Eye & Shackle Bushing Kit NEW	6-1024	
<b>(F250 Crew Cab &amp; F350 2WD- Except Super Cab)</b>			
73-79	Spring Eye w/o Frame Shackle Bushing Kit	6-1005	
<b>(F250 &amp; F350 2WD- Except F350 Chassis Cab)</b>			
80-98	Spring Eye & Shackle Bushing Kit	6-1007	
80-98	Frame Shackle Bushing Kit	6-806	
80-98	Spring Eye & Shackle Bushing Kit (Molded In Frame Shackles)	6-1020	
80-98	Frame Shackle Bushing Kit (Molded In Frame Shackles)	6-811	
<b>(E250, E350 Van 2WD)</b>			
92-06	Spring Eye & Shackle Bushing Kit NEW	6-1021	
<b>(F350 Super Cab 2WD)</b>			
73-79	Spring Eye & Shackle Bushing Kit	6-1006	
73-79	Frame Shackle Bushing Kit	6-809	
<b>(Excursion 2WD)</b>			
99-04	Spring & Shackle Bushing Kit NEW	6-1026	
<b>(Explorer 2WD)</b>			
91-94	Spring Eye & Shackle Bushing Kit	6-1019	
91-94	Frame Shackle Bushing Kit	6-810	



**#6-1710 F150 '04-'05 2.5" Lift Front Coil Spring Lift Kit**

FORD full sized trucks continued...

## SPRING & SHACKLE BUSHINGS, Rear 4WD

<b>(F100, F150 4WD)</b>		
66-72	Spring Eye & Shackle Bushing Kit	6-1008
66-72	Frame Shackle Bushing Kit	6-803
73-79	Spring Eye & Shackle Bushing Kit	6-1004
73-79	Frame Shackle Bushing Kit	6-804
80-96	Spring Eye & Shackle Bushing Kit	6-1007
80-96	Frame Shackle Bushing Kit	6-806
80-96	Spring Eye & Shackle Bushing Kit (Molded In Frame Shackles)	6-1020
80-96	Frame Shackle Bushing Kit (Molded In Frame Shackles)	6-811
97-03	Spring Eye & Shackle Bushing Kit	6-1024
<b>(F250, F350 4WD)</b>		
73-77	Spring Eye & Shackle Bushing Kit	6-1003
73-77	Frame Shackle Bushing Kit	6-807
99-04	Spring Eye & Shackle Bushing Kit	6-1026
<b>(F250, F350 4WD)</b>		
77-79	Spring Eye & Shackle Bushing Kit (w/ 3" wide springs)	6-1004
77-79	Frame Shackle Bushing Kit	6-804
80-98	Spring Eye & Shackle Bushing Kit	6-1007
80-98	Frame Shackle Bushing Kit	6-806
80-98	Spring Eye & Shackle Bushing Kit (Molded In Frame Shackles)	6-1020
80-98	Frame Shackle Bushing Kit (Molded In Frame Shackles)	6-811
<b>(Bronco 4WD)</b>		
66-77	Spring Eye & Shackle Bushing Kit	6-1008
66-77	Frame Shackle Bushing Kit	6-803
78-79	Spring Eye & Shackle Bushing Kit	6-1004
78-79	Frame Shackle Bushing Kit	6-804
80-96	Spring Eye & Shackle Bushing Kit	6-1007
80-96	Frame Shackle Bushing Kit	6-806
80-96	Spring Eye & Shackle Bushing Kit (Molded In Frame Shackles)	6-1020
80-96	Frame Shackle Bushing Kit (Molded In Frame Shackles)	6-811
<b>(Explorer 4WD)</b>		
91-94	Spring Eye & Shackle Bushing Kit	6-1019
91-94	Frame Shackle Bushing Kit	6-810



#6-1154-BL F150 & F250 4WD Front Sway Bar Bushing Kit

## SWAY BAR BUSHINGS & END LINKS, Front / Rear

<b>(F150, 2WD) (F250, 2WD Light Duty to '99)</b>		
97-03	Front Sway Bar & End Link Bushing Kit, 30mm Bar	6-1130
04-06	Front Sway Bar & End Link Bushing Kit, 34mm Bar	6-1168
<b>(F150, 4WD) (F250, 4WD Light Duty to '99)</b>		
97-02	Front Sway Bar & End Link Bushing Kit, 27mm Bar	6-1154
04-06	Front Sway Bar & End Link Bush. Kit, 34mm Bar	6-1168
<b>(F150, 2WD &amp; 4WD)</b>		
04-05	Front Sway Bar Bushing Kit, 34mm Bar	6-1158
<b>(F250 Super Duty (SD) 4WD)</b>		
99-3/99	Front & Rear Sway Bar Bushing Kit, 32mm Bar	6-1167
9912-04	Front Sway Bar Bushing Kit, 30mm Bar	6-1165
4/99-04	Front Sway Bar Bushing Kit, 32mm Bar	6-1166
<b>(F350 4WD)</b>		
88-94	Front Sway Bar & End Link Bushing Kit, 1-1/8" Bar	6-1146
<b>(E250, E350 2WD Van)</b>		
92-06	Front Sway Bar & End Link Bushing Kit, 1" Bar	6-1151
<b>(Explorer 2WD &amp; 4WD)</b>		
91-94	Front Sway Bar & End Link Bushing Kit, 23mm Bar	6-1108
91-94	Rear Sway Bar & End Link Bushing Kit, 16mm Bar	6-1114
95-01	Front Sway Bar & End Link Bushing Kit, 1.430" Bar	6-1131
95-01	Rear Sway Bar & End Link Bushing Kit, .765" Bar	6-1132
02-04	Front Sway Bar Bushing Kit, 30mm Bar	6-1159
02-04	Rear Sway Bar Bushing Kit, 21mm Bar	6-1160
<b>(Expedition 2WD &amp; 4WD, Navigator 2WD &amp; 4WD)</b>		
97-03	4WD Front Sway Bar & End Link Bushing Kit, 33mm Bar	6-1138
97-03	4WD Rear Sway Bar & End Link Bushing Kit, 22mm Bar	6-1143
97-03	2WD Front Sway Bar & End Link Bushing Kit, 32mm Bar	6-1144
97-03	2WD Rear Sway Bar & End Link Bushing Kit, 21mm Bar	6-1145



#6-1021 E250 & E350 2WD Van '92-'06 Spring Eye & Shackle Bushing Kit

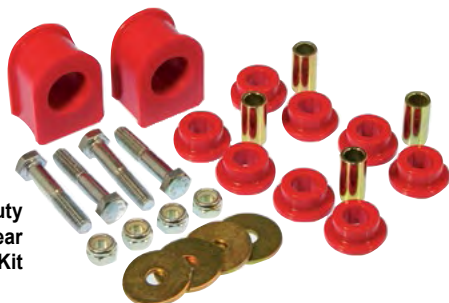

#6-1167 F250 Super Duty 4WD '99 Front & Rear Sway Bar Bushing Kit



# 6-1108-BL Explorer 2WD & 4WD Front Sway Bar & End Link Bushing Kit, 23mm Bar



FORD full sized trucks continued...

## SWAY BAR WITH 2" TALL FRAME BUSHINGS & STUD END TO EYE BOLT END LINKS, Front / Rear

(F100, F150, F250, F350, Bronco 2WD & 4WD)

70-98	Sway Bar & End Link Bushing Kit, 5/8" Bar	6-1109
70-98	Sway Bar & End Link Bushing Kit, 3/4" Bar	6-1110
70-98	Sway Bar & End Link Bushing Kit, 7/8" Bar	6-1111
70-98	Sway Bar & End Link Bushing Kit, 1" Bar	6-1112
70-98	Sway Bar & End Link Bushing Kit, 1-1/8" Bar	6-1113

## SWAY BAR WITH 2" TALL FRAME BUSHINGS & EYE BOLT TO EYE BOLT END LINKS, Front / Rear

(F100, F150, F250, F350, Bronco 2WD & 4WD)

70-98	Sway Bar & End Link Bushing Kit, 5/8" Bar	6-1114
70-98	Sway Bar & End Link Bushing Kit, 3/4" Bar	6-1115
70-98	Sway Bar & End Link Bushing Kit, 7/8" Bar	6-1116
70-98	Sway Bar & End Link Bushing Kit, 1" Bar	6-1117
70-98	Sway Bar & End Link Bushing Kit, 1-1/8" Bar	6-1118

## SWAY BAR WITH 2-1/2" TALL FRAME BUSHINGS & STUD END TO EYE BOLT END LINKS, Front / Rear

(F100, F150, F250, F350, Bronco 2WD & 4WD)

75-98	Sway Bar & End Link Bushing Kit, 7/8" Bar	6-1101
75-98	Sway Bar & End Link Bushing Kit, 1" Bar	6-1102
75-98	Sway Bar & End Link Bushing Kit, 1-1/8" Bar	6-1103

## SWAY BAR WITH 2-1/2" TALL FRAME BUSHINGS & EYE BOLT TO EYE BOLT END LINKS, Front / Rear

(F100, F150, F250, F350, Bronco 2WD & 4WD)

77-98	Sway Bar & End Link Bushing Kit, 7/8" Bar	6-1104
77-98	Sway Bar & End Link Bushing Kit, 1" Bar	6-1105
77-98	Sway Bar & End Link Bushing Kit, 1-1/8" Bar	6-1106

## SWAY BAR WITH 3-1/2" TALL FRAME BUSHINGS & EYE BOLT TO EYE BOLT END LINKS, Front / Rear

(F100, F150, F250, F350, Bronco 2WD & 4WD)

70-98	Sway Bar & End Link Bushing Kit, 7/8" Bar	6-1127
70-98	Sway Bar & End Link Bushing Kit, 23mm Bar	6-1108
70-98	Sway Bar & End Link Bushing Kit, 1" Bar	6-1128
70-98	Sway Bar & End Link Bushing Kit, 1-1/8" Bar	6-1129

## TIE ROD BOOTS

65-98	Tie Rod Boot Kit (2)	19-1712
<b>(E250, E350 2WD Van)</b>		
92-06	Tie Rod Boot Kit (2)	19-1712

## TRANSFER CASE MOUNTS

(F150, F250, Bronco 4WD)

60-76	Transfer Case Mount Kit (F150 & F250)	6-1601
66-77	Transfer Case Mount Kit (Bronco)	6-1602

## TOTAL KITS

(Bronco I)

66-77	Total Kit	6-2016
-------	-----------	--------

(Explorer 4WD)

91-94	Total Kit	6-2019
-------	-----------	--------

(F100, F150 2WD)

66-79	Total Kit*	6-2020
-------	------------	--------

(F150 2WD)

87-96	Total Kit	6-2028
-------	-----------	--------

97-03 Total Kit (Standard, Extended & Crew Cab)

(F150, 4WD)		6-2035
-------------	--	--------

73-79	Total Kit	6-2017
-------	-----------	--------

80-96	Total Kit	6-2018
-------	-----------	--------

(F150 2 & 4WD)

04-06	Total Kit F150 2 & 4WD	6-2038
-------	------------------------	--------

(F150/F250 Light Duty 4WD)

97-03	Total Kit (Standard, Extended & Crew Cab)	6-2036
-------	---	--------

(F250 4WD)

80-98	F250 Total Kit	6-2027
-------	----------------	--------

99-04	F250 Super Duty (SD) Total Kit	6-2037
-------	--------------------------------	--------

\*Does Not Fit Trucks With 3 Bushing Shackles



#6-2035-BL F150 2WD '97-03 Total Kit

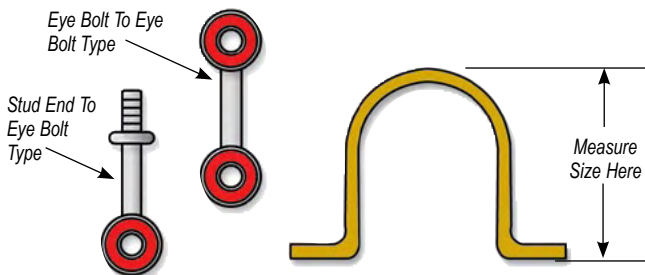

Ford Type Sway Bar Configurations



#6-2037 F250 Super Duty '99-04 Total Kit

## Ford Trucks, Ranger & Bronco II

### AXLE PIVOT BUSHINGS

<b>(2WD)</b>		
83-97	Axle Pivot Bushing Kit, w/o Shells	6-605
<b>(Ranger 4WD)</b>		
83-97	Axle Pivot Bushing Kit, w/o Shells	6-601
<b>(Bronco II 4WD)</b>		
84-90	Axle Pivot Bushing Kit, w/o Shells	6-601

### BODY & CAB MOUNTS, 2WD & 4WD

<b>(Ranger 2WD &amp; 4WD)</b>		
83-97	12 Bushing Kit	6-106
<b>(Bronco II 2WD &amp; 4WD)</b>		
84-88	20 Bushing Kit	6-104

### COIL SPRING LIFT SPACERS

<b>(Ranger 2WD)</b>		
83-86	Ranger Front Coil Spring Lift Kit, 2" Lift	6-1711

### CONTROL ARM BUSHINGS, Front

<b>(Ranger 2WD &amp; 4WD)</b>		
98-11	Front Control Arm Bushing Kit, w/o Shells	6-213

### STRUT BUSHINGS

<b>(2WD &amp; 4WD)</b>		
84-97	Strut Arm Bushing Kit	6-1210

### SPRING & SHACKLE BUSHINGS, Rear

<b>(2WD &amp; 4WD)</b>		
83-85	Spring Eye & Shackle Bushing Kit (w/Plastic Frame Shackles)	6-1017
83-85	Frame Shackle Bushing Kit	6-805
83-88	Spring Eye & Shackle Bushing Kit (w/Common Frame Shackles)	6-1003
83-88	Frame Shackle Bushing Kit	6-807
86-97	Spring Eye & Shackle Bushing Kit (w/Molded-In Frame Shackles)	6-1018
86-97	Frame Shackle Bushing Kit	6-808
98-11	Leaf Spring Bushing Kit (Ranger 4WD)	6-1027

### SWAY BAR BUSHINGS, Front

<b>(2WD &amp; 4WD)</b>		
83 1/2-89	Sway Bar Bushing Kit, 1-1/8" Bar (Trucks Not Equipped With Front End Links)	6-1107

### SWAY BAR WITH 2" TALL FRAME BUSHINGS & STUD END TO EYE BOLT END LINKS, Front / Rear

<b>(2WD &amp; 4WD)</b>		
83-97	Sway Bar & End Link Bushing Kit, 5/8" Bar	6-1109
83-97	Sway Bar & End Link Bushing Kit, 3/4" Bar	6-1110
83-97	Sway Bar & End Link Bushing Kit, 7/8" Bar	6-1111
83-97	Sway Bar & End Link Bushing Kit, 1" Bar	6-1112
83-97	Sway Bar & End Link Bushing Kit, 1-1/8" Bar	6-1113

### SWAY BAR WITH 2" TALL FRAME BUSHINGS & EYE BOLT TO EYE BOLT END LINKS, Front / Rear

<b>(2WD &amp; 4WD)</b>		
83-97	Sway Bar & End Link Bushing Kit, 5/8" Bar	6-1114
83-97	Sway Bar & End Link Bushing Kit, 3/4" Bar	6-1115
83-97	Sway Bar & End Link Bushing Kit, 7/8" Bar	6-1116
83-97	Sway Bar & End Link Bushing Kit, 1" Bar	6-1117
83-97	Sway Bar & End Link Bushing Kit, 1-1/8" Bar	6-1118

### SWAY BAR WITH 2-1/2" TALL FRAME BUSHINGS & STUD END TO EYE BOLT END LINKS, Front / Rear

<b>(2WD &amp; 4WD)</b>		
83-97	Sway Bar & End Link Bushing Kit, 7/8" Bar	6-1101
83-97	Sway Bar & End Link Bushing Kit, 1" Bar	6-1102
83-97	Sway Bar & End Link Bushing Kit, 1-1/8" Bar	6-1103

### SWAY BAR WITH 2-1/2" TALL FRAME BUSHINGS & EYE BOLT TO EYE BOLT END LINKS, Front / Rear

<b>(2WD &amp; 4WD)</b>		
83-97	Sway Bar & End Link Bushing Kit, 7/8" Bar	6-1104
83-97	Sway Bar & End Link Bushing Kit, 1" Bar	6-1105
83-97	Sway Bar & End Link Bushing Kit, 1-1/8" Bar	6-1106

### SWAY BAR WITH 3-1/2" TALL FRAME BUSHINGS & EYE BOLT TO EYE BOLT END LINKS, Front / Rear

<b>(2WD &amp; 4WD)</b>		
83-97	Sway Bar Bushing Kit, 7/8" Bar	6-1127
83-97	Sway Bar & End Link Bushing Kit, 23mm Bar	6-1108
83-97	Sway Bar & End Link Bushing Kit, 1" Bar	6-1128
83-97	Sway Bar & End Link Bushing Kit, 1-1/8" Bar	6-1129

### TIE ROD BOOTS

<b>(Ranger 2WD &amp; 4WD, Bronco II 4WD)</b>		
83-02	Tie Rod Boot Kit (2)	19-1712

### TOTAL KITS

84-88	Total Kit (Bronco II, 4WD)	6-2023
83-97	Total Kit (Ranger, 2WD STD & Extra Cab)	6-2021
83-97	Total Kit (Ranger, 4WD STD & Extra Cab)	6-2022

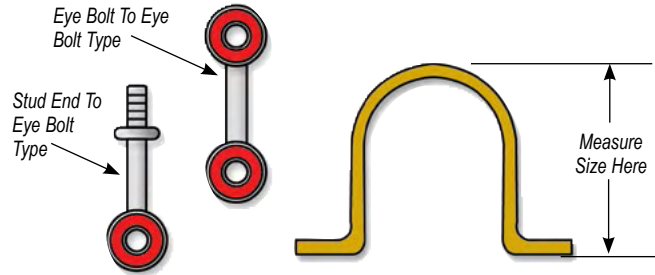

Ford Type Sway Bar Configurations



#6-2021 Ranger 2WD '83-97 Total Kit

## Honda

### BALL JOINT BOOTS

84-87 (2 Kits required.)	Front Ball Joint Boot Kit (2) (Civic/CRX)	19-1712
88-00	Front Ball Joint Boot Kit (4) (Civic/CRX/Del Sol)	8-1701
90-97 (CR-V)	Front Ball Joint Boot Kit (4) (Accord)	8-1702
97-01	Front Ball Joint Boots	8-1701

### BILLET REAR UPPER CONTROL & COMPENSATOR ARMS

<b>(Civic '92-00, CR-V '97-01, Del Sol '93-97, CRX, Wagon &amp; Sedan '88-91) Various</b>		
	Billet Rear Upper Control Arms (w/Prothane logo)	8-321
<b>(Civic '92-95, CR-V '97-01, Del Sol '93-97, CRX, Wagon '88-91, Sedan '88-89) Various</b>		
	Billet Rear Compensator Arms (w/Prothane logo)	8-322

### CONTROL ARM BUSHINGS, Front

<b>(Accord)</b>		
86-89	Lower Control Arm Bushing Kit	8-210
90-93	Control Arm Bushing Kit, Upper & Lower	8-204
90-93	Lower Control Arm Bushing Kit	8-214
94-97	Control Arm Bushing Kit, Upper & Lower	8-205
90-97	Upper Control Arm Bushing Kit	8-213
94-97	Lower Control Arm Bushing Kit	8-216
98-02	Lower Control Arm Bushing Kit	8-227

<b>(Civic/CRX/Del Sol**)</b>		
84-87	Lower Control Arm Bushing Kit	8-201
88-91	Control Arm Bushing Kit, Upper & Lower	8-202
88-91	Upper Control Arm Bushing Kit	8-209
88-91	Lower Control Arm Bushing Kit	8-210
92-95	Control Arm Bushing Kit, Upper & Lower	8-203
92-95	Upper Control Arm Bushing Kit	8-211
92-95	Lower Control Arm Bushing Kit	8-212
96-00	Control Arm Bushing Kit, Upper & Lower	8-218
96-00	Upper Control Arm Bushing Kit	8-219
96-00	Lower Control Arm Bushing Kit	8-220
01-02	Lower Control Arm Bushing Kit	8-215
06-11	Front Control Arm Bushing Kit	8-223

<b>(Civic SI)</b>		
99-00	Control Arm Bushing Kit, Upper & Lower	8-221
99-00	Upper Control Arm Bushing Kit	8-219
99-00	Lower Control Arm Bushing Kit	8-222

<b>(CR-V)</b>		
97-01	Front Control Arm Bushing Kit	8-218

<b>(Prelude)</b>		
92-96	Control Arm Bushing Kit, Upper & Lower	8-205
<b>(S2000)</b>		
99-09	Front Control Arm Bushing Kit	8-224

### CONTROL ARM BUSHINGS, Rear

<b>(Accord)</b>		
86-97	Lower Control Arm Bushing Kit	8-312
90-97	Control Arm Bushing Kit, Upper & Lower	8-313
90-97	Upper Control Arm Bushing Kit	8-311

<b>(Civic/CRX/Del Sol**)</b>		
84-87	Control Arm Bushing Kit	8-301
88-95	Control Arm Bushing Kit, Upper & Lower	8-305
88-00	Upper Control Arm Bushing Kit	8-307
88-95	Lower Control Arm Bushing Kit	8-302
96-00	Control Arm Bushing Kit, Upper & Lower	8-306
96-00	Lower Control Arm Bushing Kit	8-308
88-00	Compensator Arm Bushing Kit	8-309
01-02	Control Arm Bushing Kit, Upper & Lower	8-318
06-11	Control Arm Bushing Kit	8-319

<b>(Civic SI)</b>		
99-00	Control Arm Bushing Kit, Upper & Lower	8-306
99-00	Upper Control Arm Bushing Kit	8-307
99-00	Lower Control Arm Bushing Kit	8-308
99-00	Compensator Arm Bushing Kit	8-309
<b>(CR-V)</b>		
97-01	Rear Control Arm Bushing Kit	8-306
97-01	Rear Compensator Bushing Kit	8-309
<b>(Prelude)</b>		
92-96	Control Arm Bushing Kit, Upper & Lower	8-315
<b>(S2000)</b>		
99-09	Rear Control Arm Bushing Kit	8-320

### DIFFERENTIAL BUSHINGS

<b>(S2000)</b>		
99-09	Rear Differential Bushing Kit	8-1603

### MOTOR MOUNT INSERTS

<b>(Accord 4 cyl. only)</b>		
90-97	Engine Mount Insert Kit, (Rear)	8-514
94-97	Engine Mount Insert Kit, (Front)	8-515
94-97	Front & Rear Engine Mount Kit	8-1907
<b>(Civic/CRX)</b>		
88-91	Engine Mount Insert Kit (Left Upper)	8-506
88-91	Trans. Mount Insert Kit (Right Upper)	8-507
88-91	Firewall Mount Insert Kit (Rear)	8-508
88-91	Engine Mount Insert Kit (Front)	8-517
88-91	All 4 Mounts Kit	8-1903
<b>(Civic/Del Sol)</b>		
92-95	Engine Mount Insert Kit (Left Upper) (1.6 Ltr.) (Exc. 92-93 SI)	8-501
92-95	Trans. Mount Insert Kit (Right Upper)	8-502
92-95	Firewall Mount Insert Kit (Rear)	8-503
92-95	All 3 Mounts Kit (1.6 Ltr.) (Exc. 92-93 SI)	8-1901
<b>(Civic)</b>		
96-00	Engine Mount Insert Kit (Left Upper)	8-504
96-00	Trans. Mount Insert Kit (Right Upper)	8-505
96-00	Firewall Mount Insert Kit (Rear)	8-503
96-00	All 3 Mounts Kit	8-1902
02-05	Motor Mount Inserts	8-518
<b>(Civic SI)</b>		
99-00	Engine Mount Insert Kit (Left Upper)	8-504
99-00	Trans. Mount Insert Kit (Right Upper)	8-505
99-00	Firewall Mount Insert Kit (Rear)	8-509
99-00	All 3 Mounts Kit	8-1906

### REAR TRAILING ARM BUSHINGS

<b>(Civic, CRX, Del Sol)</b>		
88-00	Rear Trailing Arm Bushing Kit	8-304

<b>(Prelude)</b>		
92-96	Rear Trailing Arm Bushing Kit	8-316

### SHIFTER STABILIZER BUSHINGS

<b>(Civic/CRX/Del Sol)</b>		
84-87	Shifter Stabilizer Bushing Kit (Civic/CRX)	8-1601
88-00	Shifter Stabilizer Bushing Kit (Civic/CRX)	8-1602
99-00	Shifter Stabilizer Bushing Kit (Civic SI)	8-1601
93-97	Shifter Stabilizer Bushing Kit (Del Sol VTEC)	8-1601
93-97	Shifter Stabilizer Bushing Kit (Del Sol non VTEC)	8-1602

### SHOCK BUSHINGS

<b>(Accord)</b>		
86-89	Front Lower Shock Bushing Kit	8-907
90-97	Front Shock Bushing Kit*	8-903

<b>(Civic/CRX/Del Sol**)</b>		
88-00	Front Shock Bushing Kit*	8-901
88-95	Rear Shock Bushing Kit*	8-902
96-00	Rear Shock Bushing Kit (Civic)*	8-904

\*\*For 93-97 Del Sol use 92-95 Civic listings  
\*(Kit Includes Fork Bushings)

<b>(Civic SI)</b>		
99-00	Front Shock Bushing Kit*	8-905
99-00	Rear Shock Bushing Kit*	8-904

<b>(Prelude)</b>		
92-00	Front Shock Bushing Kit*	8-903
92-96	Rear Shock Bushing Kit*	8-906

<b>(CR-V)</b>		
97-01	Front Shock Bushing Kit NEW	8-901
97-01	Rear Shock Bushing Kit NEW	8-904

### SPRING ISOLATORS

<b>(Accord)</b>		
90-97	Front Coil Spring Isolator Kit (Upper)	8-1703
<b>(Prelude)</b>		
92-00	Front Coil Spring Isolator Kit (Upper)	8-1703



#8-322 Billet Rear Compensator Arms  
#8-321 Billet Rear Upper Control Arms

Continued...

## STEERING

(Civic/CRX/Del Sol)

88-91	Rack & Pinion Bushing Kit (Power Steer. Only)	8-701
92-95	Rack & Pinion Bushing Kit (Power Steer. Only)	8-702
96-00	Rack & Pinion Bushing Kit	8-704
<b>(S2000)</b>		
99-09	Rack & Pinion Bushing Kit	8-704

## STRUT ROD BUSHINGS

86-89	Front Strut Rod Bushing Kit (Accord)	8-1201
88-91	Front Strut Rod Bushing Kit (Civic/CRX)	8-1201
90-97	Front Strut Rod Bushing Kit (Accord)	8-1202
92-00	Front Strut Rod Bushing Kit (Prelude)	8-1202

## SWAY BAR BUSHINGS & END LINKS, Front

(Accord)

86-89	End Link Kit	8-401
90-97	Sway Bar Bushing Kit, 25mm Bar	8-1113
90-97	End Link Kit	8-402
90-97	8 Piece OEM Style Bushing Kit	8-403
94-97	Sway Bar Bushing Kit, 22mm Bar	8-1115
98-02	Sway Bar Bushing Kit, 26.5mm (4 cyl. Only)	8-1127
98-02	Sway Bar Bushing Kit, 27.2mm (6 cyl. Only)	8-1128

(Civic/CRX/Del Sol\*\*)

84-87	Sway Bar Bushing Kit, 16mm Bar*	8-1103
88-91	Sway Bar Bushing Kit, 16mm Bar*	8-1105
88-91	Sway Bar Bushing Kit, 16mm Bar	8-1122
88-91	Sway Bar Bushing Kit, 18mm Bar	8-1106
88-91	Sway Bar Bushing Kit, 19mm Bar	8-1107
88-00	End Link Kit	8-401
92-95	Sway Bar Bushing Kit, 21mm Bar*	8-1101
92-95	Sway Bar Bushing Kit, 21mm Bar	8-1121
92-95	Sway Bar Bushing Kit, 22mm Bar	8-1109
92-95	Sway Bar Bushing Kit, 24mm Bar	8-1110
96-00	Sway Bar Bushing Kit, 22mm Bar	8-1123
01-05	Sway Bar Bushing Kit, 25.4mm Bar	8-1133

\*Kit Includes End Links

\*\*For 93-97 DelSol use 92-95 Civic listings

(Civic/CRX/Del Sol\*\*)

06-10	Sway Bar Bushing Kit, 27mm Bar (Civic)	8-1139
06-11	Sway Bar Bushing Kit (Front & Rear) NEW	8-1143

(Civic Si)

99-00	Sway Bar Bushing Kit, 26mm Bar	8-1125
-------	--------------------------------	--------

(Prelude)

92-96	End Link Kit	8-404
92-96	Sway Bar Bushing Kit, 25.4mm Bar	8-1130
97-01	Sway Bar Bushing Kit, 25.4mm Bar (S Model)	8-1130
97-01	Sway Bar Bushing Kit, 24.2mm Bar (SH Model)	8-1131

(S2000)

99-09	Sway Bar Bushing Kit, 28mm Bar NEW	8-1144
-------	------------------------------------	--------

## SWAY BAR BUSHINGS, Rear

(Accord)

90-97	Sway Bar Bushing Kit, 14mm Bar	8-1116
94-97	Sway Bar Bushing Kit, 15mm Bar	8-1108
98-02	Sway Bar Bushing Kit, 16mm Bar (4 cyl. Only)	8-1126
98-02	Sway Bar Bushing Kit, 17mm Bar (6 cyl. Only)	8-1129

(Civic/CRX/Del Sol\*\*)

84-87	Sway Bar Bushing Kit, 14mm Bar	8-1104
88-91	Sway Bar Bushing Kit, 15mm Bar	8-1108
92-95	Sway Bar Bushing Kit, 13mm Bar	8-1111
99-00	Sway Bar Bushing Kit, 13mm Bar (Civic Si)	8-1124
01-05	Sway Bar Bushing Kit, 12mm Bar	8-1134
06-10	Sway Bar Bushing Kit, 11mm Bar	8-1141
06-10	Sway Bar Bushing Kit, 17mm Bar	8-1142
06-10	Sway Bar Bushing Kit, 25.4mm Bar (Civic)	8-1138
06-10	Sway Bar Bushing Kit, 28mm	8-1140
06-11	Sway Bar Bushing Kit, (Front: 25mm, 27mm & 28mm Bars & Rear: 11mm, 17mm Bars)	8-1143

\*\*For 93-97 Del Sol use 92-95 Civic listings

(Prelude)

92-00	Sway Bar Bushing Kit, 23mm Bar	8-1132
-------	--------------------------------	--------

(S2000)

99-09	Sway Bar Bushing Kit, 27mm Bar	8-1145
-------	--------------------------------	--------

## TIE ROD BOOTS

84-00	Tie Rod Boot Kit (2) (Civic, CRX, Del Sol)	19-1711
90-97	Tie Rod Boot Kit (2) (Accord)	19-1711
97-01	Tie Rod Boot Kit (CR-V)	19-1711

## STRUT ROD BUSHINGS

(Prelude)

97-01	Front Strut (Radius) Rod Bushing Kit	8-1204
-------	--------------------------------------	--------

## TOTAL KITS\*

(Accord)

90-93	Total Kit (w/o Rear Upper Control Arm Bushings)	8-2006
90-93	Total Kit (with Rear Upper Control Arm Bushings)	8-2013
94-97	Total Kit (w/o Rear Upper Control Arm Bushings)	8-2007
94-97	Total Kit (with Rear Upper Control Arm Bushings)	8-2014

(Civic, CRX, Del Sol\*\*)

84-87	Total Kit	8-2001
88-91	Total Kit (w/o Rear Upper Control Arm Bushings)†	8-2002
88-91	Total Kit (with Rear Upper Control Arm Bushings)†	8-2009
92-95	Total Kit (w/o Rear Upper Control Arm Bushings)†	8-2003
92-95	Total Kit (with Rear Upper Control Arm Bushings)†	8-2010
96-00	Total Kit (With Frt. & Rr. Upper Control Arm Bushings)	8-2008
96-00	Total Kit (w/o Frt. & Rr. Upper Control Arm Bushings)	8-2017
01-05	Total Kit	8-2019
06-11	Total Kit	8-2020

\*Total Kits do not contain the Rear Trailing Arm Bushings

\*\*For 93-97 Del Sol use 92-95 Civic listings

†(Does not include Sway Bar Bushings)

(Civic Si)

99-00	Total Kit (w/o Frt. & Rr. Upper Control Arm Bushings)	8-2016
99-00	Total Kit (with Frt. & Rr. Upper CA Bushings)	8-2015

(CR-V)

97-01	Total Kit (with Compensator Arm Bushings) NEW	8-2021
-------	---	--------

(Prelude)

92-96	Total Kit †	8-2018
-------	-------------	--------

(S2000)

99-09	Total Kit	8-2022
-------	-----------	--------

\*Total Kits do not contain the Rear Trailing Arm Bushings

†(Does not include Sway Bar Bushings)

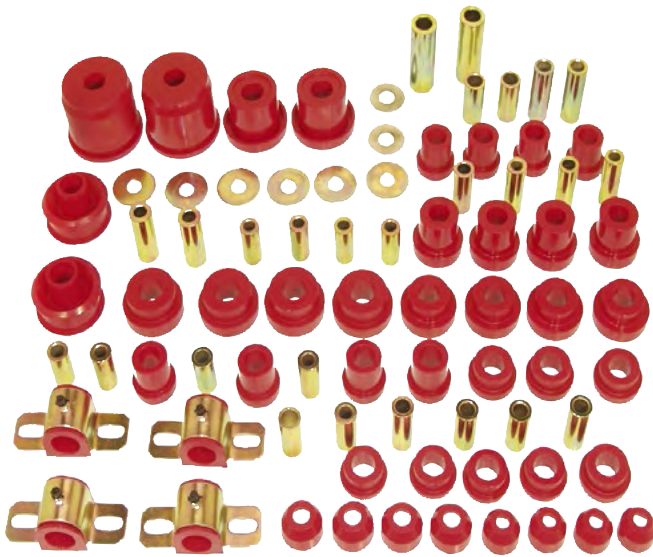

#8-2022 S2000 '99-09 Total Kit



#8-2015 Civic Si '99-00 Total Kit

## Hyundai

### MOTOR MOUNT INSERTS

(Tiburon)

03-08 Front Or Rear Motor Mount Insert Kit (V6 Only)

## Infiniti

(G35)

### DIFFERENTIAL BUSHING SET

03-07 Differential Bushing Kit NEW

### CONTROL ARM BUSHING SET, Front

03-07 Control Arm & Radius Arm Bushing Kit

### CONTROL ARM BUSHING SET, Rear

03-07 Control Arm, Radius Arm, Lower Link Bush.

### STEERING

03-07 Rack & Pinnion Bushing Kit

### SUBFRAME BUSHING SET

03-07 Subframe Bushing Kit

### SWAY BAR BUSHINGS, Front

03-07 Front Sway Bushing Kit, 1 1/4" Bar

### SWAY BAR BUSHINGS, Rear

03-07 Rear Sway Bar Bushing Kit, 21mm

### TOTAL KIT

03-07 Total Kit 14-2007

## International

### BODY MOUNTS

72-81 Body Mount Kit, 16 Pcs (Scout II)

### LEAF SPRING & SHACKLE BUSHINGS

(Scout 80)

61-65 Front Spring Eye and Shackle Bushing Kit

61-65 Rear Spring Eye and Shackle Bushing Kit

61-68 Shackle Bushing Kit For 9-1002

(Scout 800)

66-68 Front Spring Eye & Shackle Kit 7/8" I.D. Spring

66-68 Rear Spring Eye and Shackle Kit 7/8" I.D. Spring

68-71 Front Spring Eye and Shackle Kit 1 3/16" I.D. Spring

68-71 Rear Spring Eye and Shackle Kit 1 3/16" I.D. Spring

61-68 Shackle Bushing Kit For 9-1002

68-71 Shackle Bushing Kit For 9-1003

(Scout II)

72-81 Front Spring Eye and Shackle Kit

72-81 Rear Spring Eye and Shackle Kit

72-81 Shackle Bushing Only For 9-1001

### TIE ROD BOOTS

61-81 Tie Rod Boot Kit (2) (Scout 80, 800 & II)



#14-2007-BL Infiniti G35 '03-07 Total Kit

## Jaguar

### CONTROL ARM BUSHINGS, Front

(XJ6 '68 to '72, E Type '61 to '75, MK2 '60 to '67)

60-75 Control Arm Bushing Kit, Lower Inner

60-75 Control Arm Bushing Kit, Upper Inner

(XK150)

60-61 Control Arm Bushing Kit, Lower Inner

60-61 Control Arm Bushing Kit, Upper Inner

### TORQUE ARM BUSHINGS, Rear

(Mark 2)

60-67 Torque Arm Bushing Kit, Upper Front or Rear

### DRIVE TRAIN

(Mark 2)

60-67 Panhard Rod Bushing Kit

### SPRING EYE BUSHINGS

(Mark 2)

60-67 Rear Spring Eye Bushing Kit, Rear Eye

### SPRING PADS

(Mark 2)

60-67 Rear Spring Pad Kit

### STEERING

(Mark 2)

60-67 Steering Drag Link Kit

(XJ12, XJS, XKE V12)

73-75 Steering Rack Mount Kit

### SWAY BAR BUSHINGS, Front

(XJ6)

61-75 Sway Bar Bushing Kit, 17mm Bar

61-75 Sway Bar Bushing Kit, 22mm Bar

(XJ12, XJS, XKE V12)

73-75 Sway Bar Bushing Kit, 21mm Bar

69-75 Sway Bar Bushing Kit, 20mm Bar (XJ6 only)

73-75 Sway Bar Bushing Kit, 19mm Bar

### SWAY BAR END LINKS, Front

(XJ6, MK2 '60 & Later, XJ12 '73 & Later, XJS, XKE V12, XJ6 '69 & Later)

61-75 End Link Kit

(XJ12, XJS '73 & Later, XKE V12, XJ6 '69 & Later)

69-75 End Link Kit

(XK 120/140/150 All, Mark 7/8/9 All)

49-61 End Link Kit



#11-45038 60-61 XK150 Control Arm Bushing Kit, Lower Inner

**AXLE SNUBBERS**

(CJ5, CJ7, CJ8, Wrangler-YJ)

76-96	Axle Snubber Kit (Replaces O.E.M. #5355483)	1-1301
-------	---	--------

**BODY MOUNTS**

(CJ5, CJ7, CJ8, Wrangler TJ & YJ)

55-73	14 Bushing Kit	1-101
74-75	18 Bushing Kit	1-109
76-79	22 Bushing Kit	1-102
80-86	22 Bushing Kit	1-103
81-86	26 Bushing Kit (CJ8)	1-104
87-96	22 Bushing Kit	1-105
97-06	22 Bushing Kit	1-107

(Wrangler JK)

07-14	12 Bushing Kit (4 Door) NEW	1-117
07-17	8 Bushing Kit (2 Door) NEW	1-118

(Jeepster Commando)

67-73	26 Bushing Kit	1-108
-------	----------------	-------

(Grand Wagoneer, Wagoneer & Cherokee)

76-91	24 Bushing Kit (Grd. Wagoneer, Wagoneer)	1-106
74-83	24 Bushing Kit (Cherokee Full Size)	1-106

(Wagoneer)

63-75	24 Bushing Kit (Cherokee Full Size)	1-119
-------	-------------------------------------	-------

**BODY MOUNTS, LIFT TYPE**

(CJ5/CJ7)

76-79	Body Mount, 1" Lift (Incl. Hardware)	1-110
80-86	Body Mount, 1" Lift (Incl. Hardware)	1-111

(CJ8 Scrambler)

81-86	Body Mount, 1" Lift (Incl. Hardware)	1-112
-------	--------------------------------------	-------

(Wrangler, YJ, TJ, JK)

87-96	Body Mount, 1" Lift (Incl. Hardware)(YJ)	1-113
97-06	Body Mount, 1" Lift (Incl. Hardware)(TJ)	1-114
07-14	Body Spacer Kit, 1" Lift (Incl. Hardware)(JK)	1-116

**BUMP STOPS**

(Wrangler JK)

07-17	Front Bump Stops (2 & 4 door)	1-1303
07-17	Rear Bump Stops (2 & 4 door)	1-1304

(TJ)

97-06	Rear Bump Stops	1-1707
-------	-----------------	--------

**CONTROL ARM BUSHINGS, Front / Rear**

(Cherokee, Comanche, Grand Cherokee, Wrangler TJ)

84-01	Front Control Arm Bushing Kit (Cherokee)	1-202
93-98	Front Control Arm Bushing Kit (Grand Cherokee)	1-203
93-98	Rear Control Arm Bushing Kit (Grand Cherokee)	1-301
97-06	Ft. or Rr. C-Arm Bushing Kit (Upper & Lower) (TJ)	1-204

(Wrangler JK)

07-17	Front C-Arm Bushing Kit (2 & 4 Door)	1-211
07-17	Rear C-Arm Bushing Kit (2 & 4 Door)	1-302



#1-117 Wrangler JK '07-'14 Body Mount Kit



#1-502-BL Jeep® '86-'06 6 cyl. Motor Mounts

**HEAVY DUTY DRIVE TRAIN KIT**

(Wrangler-YJ)

87-96	Drive Train Kit (6 Cylinder)	1-1902
(Above Kits Include: Motor Mounts, Trans. Mount, Trans. Torque Arm Bushings & Axle Snubbers)		

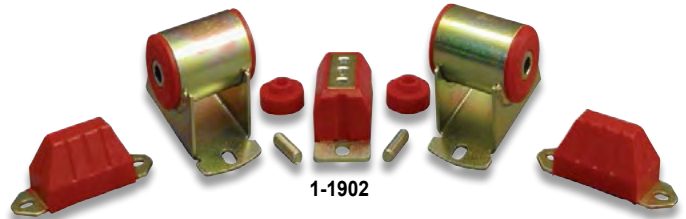

1-1902

**DRIVE TRAIN KITS**

(CJ5, CJ7, CJ8)

76-86	Drive Train Kit (6 Cylinder, 258 Ci)	1-1901
-------	--------------------------------------	--------

(Wrangler-TJ)

97-06	Drive Train Kit (6 Cylinder)	1-1903
-------	------------------------------	--------

(Kit Includes: Trans. Mount & Motor Mounts Only)

(Various, Motor and Transmission Mount Combo Kits- See Application Chart on Page 17)

**MOTOR MOUNTS**

(CJ5, CJ7, CJ8)

72-86	Motor Mount Kit (6 Cyl, 258 Ci)	1-501
-------	---------------------------------	-------

(Wagoneer & Cherokee)

74-85	Motor Mount Kit (6 Cyl, 258 Ci)	1-501
-------	---------------------------------	-------

(TJ, YJ, XJ, MJ)

87-06	Motor Mounts Kit, Pair (6 Cyl.)	1-502
-------	---------------------------------	-------

(All w/ AMC V8 Engine)

67-92	Motor Mount Kit, Pair (V8)	1-503
-------	----------------------------	-------

(Grand Wagoneer)

84-91	Motor Mount Kit, Pair (6 cyl.)	1-501
-------	--------------------------------	-------

(Grand Cherokee)

93-98	Motor Mount Insert Kit, Pair (8 cyl.)	1-504
-------	---------------------------------------	-------

**SPRING & SHACKLE BUSHINGS, Front**

(CJ5, CJ6, CJ7, CJ8 & Wrangler-YJ)

55-75	Spring Eye & Shackle Bushing Kit	1-1001
76-86	Spring Eye & Shackle Bushing Kit	1-1002
87-96	Spring Eye & Shackle Bushing Kit	1-1005

(Full Size Cherokee, Grd Wagoneer, Wagoneer & Pickup)

74-77	Spring Eye & Shackle Kit, w/ 1-1/4" OD Main Eye	1-1004
74-91	Spring Eye & Shackle Kit, w/ 2" OD Main Eye	1-1014



#1-1001 '55-'75 Spring Eye & Shackle Bushing Kit



#1-816 Jeep '87-'96 Front or Rear Greaseable Shackle Bushing Kit

**Jeep Continued...**

**SPRING & SHACKLE BUSHINGS, Rear**

<b>(CJ5, CJ6, CJ7, CJ8 &amp; Wrangler-YJ)</b>		
55-75	Spring Eye & Shackle Bushing Kit	1-1001
76-86	Spring Eye & Shackle Bushing Kit	1-1003
87-96	Spring Eye & Shackle Bushing Kit	1-1005
<b>(Cherokee, Comanche)</b>		
84-99	Spring Eye & Shackle Bushing Kit	1-1007

**SHACKLE BUSHING KITS, Front / Rear**

<b>(CJ5, CJ6, CJ7, CJ8, Wrangler-YJ)</b>		
55-75	Front or Rear Frame Shackle Bushing Kit	1-805
76-86	Front Frame Shackle Bushing Kit	1-801
76-86	Rear Frame Shackle Bushing Kit	1-802
87-96	Front or Rear Frame Shackle Bushing Kit	1-803
<b>(Cherokee, Comanche)</b>		
84-99	Rear Frame Shackle Bushing Kit	1-804

**GREASEABLE SPRING & SHACKLE BUSHINGS, Front / Rear**

<b>(CJ5, CJ7, CJ8, Wrangler-YJ)</b>		
55-75	Front & Rear Main Spring Eye Bushing Kit	1-1015
55-75	Front or Rear Shackle Bushing Kit (Upper & Lower)*	1-1015
76-86	Front & Rear Main Spring Eye Bushing Kit	1-1016
76-86	Front Shackle Bushing Kit (Upper & Lower)*	1-814
76-86	Rear Shackle Bushing Kit (Upper & Lower)*	1-815
87-96	Front & Rear Main Spring Eye Bushing Kit	1-1017
87-96	Front or Rear Shackle Bushing Kit (Upper & Lower)*	1-816

(All Greaseable Bushing Kits include: Greaseable Bolts, Sleeves, Nuts & Washers)

\*Does not work with U-Type Shackles

**COIL SPRING ISOLATORS, LIFT TYPE**

<b>(Wrangler- T.J, JK)</b>		
97-06	Front Coil Spring Isolator Kit, 1" Lift, Pair	1-1702
97-06	Rear Coil Spring Isolator Kit, 1-1/2" Lift, Pair	1-1702
97-06	Front Coil Spring Isolator Kit, 1-1/2" Lift, Pair	1-1703
97-06	Rear Coil Spring Isolator Kit, 2" Lift, Pair	1-1703
97-06	Extended Front Bump Stop Kit, 1-1/2", Pair	1-1302
97-06	1-1/2" Lift Isolator Kit, w/Extended Bump Stops	1-1705
07-14	Complete Front & Rear Coil Lift Kit 2", Pair (JK)	1-1708

**COIL SPRING ISOLATORS**

<b>(Wrangler-TJ)</b>		
97-06	Front Spring Isolator Kit, Pair	1-1701

**SWAY BAR BUSHINGS & END LINKS, Front**

<b>(CJ5, CJ7, CJ8, Wrangler-YJ, TJ, JK)</b>		
76-86	Sway Bar & End Link Bushing Kit, 15/16" Bar (CJ)	1-1101
76-86	Sway Bar & End Link Bushing Kit, 7/8" Bar (CJ)	1-1110
87-96	Sway Bar & End Link Bushing Kit, 15/16" Bar (YJ)	1-1102
87-96	Sway Bar & End Link Bushing Kit, 1-1/8" Bar (YJ)	1-1107
97-06	Sway Bar & End Link Bushing Kit, 30.5mm Bar (TJ)	1-1111
07-14	Sway Bar Bushing Kit, 30.5mm Bar (JK)	1-1125
07-17	Sway Bar & End Link Bushing Kit, 31mm Bar (JK)	1-1127
<b>(Cherokee, Comanche, Grand Cherokee 93-98, 2 &amp; 4WD)</b>		
84-01	Sway Bar & End Link Bushing Kit, 24mm Bar	1-1103
84-01	Sway Bar & End Link Bushing Kit, 25mm Bar	1-1104
84-01	Sway Bar & End Link Bushing Kit, 28mm Bar	1-1105
84-01	Sway Bar & End Link Bushing Kit, 23mm Bar	1-1106
84-01	Sway Bar & End Link Bushing Kit, 1" Bar	1-1108
84-01	Sway Bar & End Link Bushing Kit, 7/8" Bar	1-1115
84-01	Sway Bar & End Link Bushing Kit, 15/16" Bar	1-1116
84-01	Sway Bar & End Link Bushing Kit, 1 1/8" Bar	1-1117
<b>(Grand Cherokee)</b>		
99-04	Sway Bar & End Link Bushing Kit, 1-1/4" Bar	1-1113



#1-1108-BL Jeep® '84-'01 Front Sway Bar Bushing Kit

**SWAY BAR BUSHINGS & END LINKS, Rear**

<b>(Cherokee, Comanche, Wrangler, Grand Cherokee 2 &amp; 4WD)</b>		
84-01	Sway Bar & End Link Bushing Kit, 5/8" Bar (Cherokee)	1-1118
93-98	Sway Bar & End Link Bushing Kit, 5/8" Bar (Grand Cherokee)	1-1109
97-06	Sway Bar & End Link Bushing Kit, 13mm Bar (TJ)	1-1112
99-04	Sway Bar & End Link Bushing Kit, 9/16" Bar (Grand Cherokee)	1-1114
07-14	Sway Bar Bushing Kit, 19mm Bar (JK)	1-1126
07-17	Sway Bar & End Link Bushing Kit, 19mm Bar (JK)	1-1128

**TRACK ARM BUSHINGS, Front / Rear**

<b>(Cherokee, Grand Cherokee, Comanche, Wrangler- JK, TJ &amp; YJ)</b>		
87-96	Front or Rear Track Arm Bushing Kit (Wrangler YJ)	1-1202
97-06	Front Track Arm Bushing Kit (Wrangler TJ)	1-1205
97-06	Rear Track Arm Bushing Kit (Wrangler TJ)	1-1206
84-01	Front Track Arm Bushing Kit (Cherokee)	1-1203
86-92	Front Track Arm Bushing Kit (Comanche)	1-1203
93-98	Front Track Arm Bushing Kit (Grand Cherokee)	1-1203
93-98	Rear Track Arm Bushing Kit (Grand Cherokee)	1-1204
07-17	Front Track Bar Bushing Kit (2 & 4 door)	1-1209
07-17	Rear Track Bar Bushing Kit (2 & 4 door)	1-1210

**TRANSMISSION MOUNTS**

<b>(CJ5, CJ7, CJ8, Wrangler-YJ &amp; TJ)</b>		
73-96	Transmission Torque Arm Bushing Kit	1-1201
72-96	Trans. Mount Kit (Replaces O.E.M. #1370910)	7-1604
97-06	Transmission Mount Kit (Wrangler, TJ)	1-1601
<b>(J Series Pickup)</b>		
63-87	Transmission Mount Kit (6 cyl., 232 C.I. 4WD)	7-1604
75-87	Transmission Mount Kit (8 cyl., 360 C.I.)	7-1604
<b>(Cherokee, Wagoneer)</b>		
74-83	Transmission Mount Kit (6 cyl., 258 C.I.)	7-1604
72-83	Transmission Mount Kit (8 cyl., 360 C.I.)	7-1604
87-99	Transmission Mount Kit (XJ w/4.0L) NEW	1-1603
<b>(Grand Wagoneer)</b>		
80-92	Transmission Mount Kit (6 cyl.)	7-1604
84-91	Transmission Mount Kit (8 cyl., 360 C.I.)	7-1604

**TIE ROD BOOTS**

55-01	Tie Rod Boot Kit (All Models)	19-1712
-------	-------------------------------	---------

**TOTAL KITS**

<b>(CJ5 &amp; CJ7)</b>		
55-73	Total Kit	1-2001
74-75	Total Kit, (Includes Transmission Mount)	1-2013
76-79	Total Kit	1-2002
76-79	Total Kit, (Includes Transmission Mount)	1-2007
80-86	Total Kit	1-2003
80-86	Total Kit, (Includes Transmission Mount)	1-2008
<b>(CJ8 Scrambler)</b>		
81-86	Total Kit, (Includes Transmission Mount)	1-2014
<b>(Wrangler JK)</b>		
07-17	Total Kit (4 Door)	1-2017
07-17	Total Kit (2 Door)	1-2018
<b>(Wrangler YJ &amp; TJ)</b>		
87-96	Total Kit (Wrangler YJ)	1-2005
87-96	Total Kit (Wrangler YJ) (Includes Trans. Mount)	1-2009
97-06	Total Kit (Wrangler TJ)	1-2006
<b>(Cherokee, Grand Cherokee)</b>		
84-01	Total Kit (Cherokee 2 & 4WD)	1-2004
93-98	Total Kit (Grand Cherokee)	1-2016



#1-2008 Jeep® '80-'86 Total Kit with Transmission Mount

## Lexus (Available in black only)

### CONTROL ARM BUSHINGS, Front / Rear

<b>(SC 300, 400)</b>		
92-96	Front Control Arm Bushing Kit	18-207-BL
92-96	Rear Control Arm Bushing Kit	18-304-BL
<b>(GS 300, 340, 400 - 2WD ONLY)</b>		
98-00	Front Control Arm Bushing Kit	18-212-BL

### SWAY BAR BUSHINGS, Front / Rear

<b>(SC 300, 400)</b>		
92-00	Front Sway Bar Bushing Kit, 30mm Bar	18-1121-BL
92-00	Rear Sway Bar Bushing Kit, 24mm Bar	18-1122-BL
<b>(GS 300, 400, 430)</b>		
93-97	Front Sway Bar Bushing Kit, 30mm Bar	18-1128-BL
93-97	Rear Sway Bar Bushing Kit, 23mm Bar	18-1129-BL
98-05	Front Sway Bar Bushing Kit, 28.5mm Bar	18-1123-BL
98-05	Rear Sway Bar Bushing Kit, 14mm Bar	18-1124-BL
<b>(LS 300)</b>		
01-05	Front Sway Bar Bushing Kit, 27.2mm Bar	18-1119-BL
01-05	Rear Sway Bar Bushing Kit, 14mm Bar	18-1124-BL



**#18-207-BL Lexus  
SC300, 400 '92-'06 Front  
Control Arm Bushing Kit**

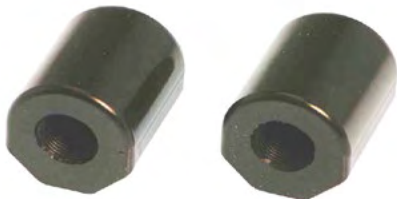

**#18-1124-BL '98-'05 Rear Sway Bar Bushing  
Kit, 14mm Bar**

**TECH TIP:**  
Urethane Control Arm and Leaf Spring  
bushings require lubrication  
with PROTHANE Teflon Super Grease  
provided in each kit

## Lincoln/Mercury

### BODY MOUNTS

<b>(Lincoln Blackwood Pickup, 2WD)</b>		
2002	Body Mount Kit	6-115

### COIL SPRING ISOLATORS

<b>(Capri)</b>		
79-86	Front Spring Isolators, Upper & Lower	6-1701
83-86	Rear Spring Isolators, Upper & Lower	6-1703

### CONTROL ARM BUSHINGS, Front

<b>(Capri)</b>		
79-86	Front Control Arm Bushing Kit, w/o Shells*	6-205
79-86	Front Control Arm Bushing Kit, w/ Shells*	6-209
79-86	Front Control Arm Bushing Kit, w/o Shells †	6-206
<b>(Cougar)</b>		
67-73	Front Control Arm Bushing Kit, w/o Shells (w/ 1-7/16" Lower)	6-202
67-73	Front Control Arm Bushing Kit, w/o Shells (w/ 1-9/16" Lower)	6-203
74-97	Front Control Arm Bushing Kit, w/o Shells	6-210
80-86	Front Control Arm Bushing Kit, w/o Shells*	6-205
80-86	Front Control Arm Bushing Kit, w/o Shells †	6-206
87-88	Front Control Arm Bushing Kit, w/o Shells *(Except HD Suspension) †(With HD Suspension)	6-211
<b>(Grand Marquis w/Police, Tow &amp; Taxi Pkg.)</b>		
92-94	Front Control Arm Bushing Kit w/o Shells*	6-215
95-97	Front Control Arm Bushing Kit w/o Shells* *(Includes Upper Coil Spring Isolators)	6-216

### CONTROL ARM BUSHINGS, Rear

<b>(Capri)</b>		
79-86	Rear Control Arm Bushing Kit, w/o Shells (w/ Round Bushings)	6-301
79-86	Rear Control Arm Bushing Kit, w/o Shells (w/ Lower Oval Bushings)	6-302
<b>(Cougar)</b>		
80-86	Rear Control Arm Bushing Kit, w/o Shells (w/ Round Bushings)	6-301
80-86	Rear Control Arm Bushing Kit, w/o Shells (w/ Lower Oval Bushings)	6-302



**#6-216 Grand Marquis '95-97 Front Control Arm Bushing Kit  
w/Upper Coil Spring Isolators**

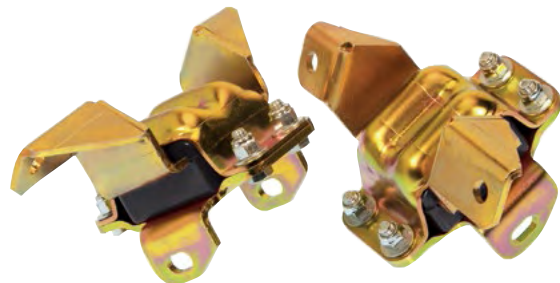

**#6-503-BL Comet, Cougar Motor Mount Set**



Continued...

## MOTOR MOUNTS

Various (See Application Charts on Pages 14-19)

## STEERING

(Capri)

79-9/84	Rack & Pinion Bushing Kit	6-702
10/84-86	Rack & Pinion Bushing Kit	6-703
10/84-86	Rack & Pinion Bushing Kit (Offset Style for Lowered Cars)	6-704

(Cougar)

85-88	Rack & Pinion Bushing Kit	6-703
85-88	Rack & Pinion Bushing Kit (Offset Style for Lowered Cars)	6-704

## STRUT ROD BUSHINGS

(Cougar)

67-73	Strut Rod Bushing Kit	6-1205
74-79	Strut Rod Bushing Kit	6-1216

## STRUT TOWER BUSHINGS

(Capri)

83-86	McPherson Strut Tower Bushing Kit	6-1213
-------	-----------------------------------	--------

## SWAY BAR BUSHINGS, Front

(Capri)

79-86	Sway Bar Bushing Kit, 7/8" Bar	6-1120
79-86	Sway Bar Bushing Kit, 15/16" Bar	6-1121
79-86	Sway Bar Bushing Kit, 1" Bar	6-1122
79-86	Sway Bar Bushing Kit, 1 1/16" Bar	6-1123
79-86	Sway Bar Bushing Kit, 1 1/8" Bar	6-1124
79-86	Sway Bar Bushing Kit, 1 1/4" Bar	6-1125
79-86	Sway Bar Bushing Kit, 1 5/16" Bar	6-1126

## SWAY BAR END LINKS, Front

(Capri)

79-86	End Link Kit	19-417
-------	--------------	--------

(Comet)

61-65	End Link Kit	19-401
66-77	End Link Kit	19-405

(Cougar)

67-73	End Link Kit	19-408
74-79	End Link Kit	19-409
80-86	End Link Kit	19-417
87-89	End Link Kit	19-412

(Monarch)

75-80	End Link Kit	19-401
-------	--------------	--------

(Marquis w/o Tow Package)

83-88	End Link Kit	19-412
-------	--------------	--------

(Versailles)

77-80	End Link Kit	19-405
-------	--------------	--------



#19-408 Cougar '67-'73 Front Sway Bar End Link Kit

## TIE ROD BOOTS

(Capri)

79-86	Tie Rod Boot Kit (2)	19-1712
-------	----------------------	---------

(Cougar)

67-88	Tie Rod Boot Kit (2)	19-1712
-------	----------------------	---------

## TRANSMISSION MOUNTS

(Capri)

79-86	Transmission Mount Kit, All	6-1604
-------	-----------------------------	--------

79-86	Transmission X-Member Bushing Kit	6-1603
-------	-----------------------------------	--------

(Comet)

66-69	Transmission Mount Kit, All	6-1605
-------	-----------------------------	--------

(Cougar)

67-73	Transmission Mount Kit, All	6-1605
-------	-----------------------------	--------

80-88	Transmission Mount Kit, All	6-1604
-------	-----------------------------	--------

## TOTAL KITS

(Capri)

79-86	Total Kit (w/o Trans. Mount)	6-2002
-------	------------------------------	--------

79-86	Total Kit (Includes Transmission Mount)	6-2005
-------	---	--------

#6-1605 Comet, Cougar '66-73  
Transmission Mount  
with Metal Polylock

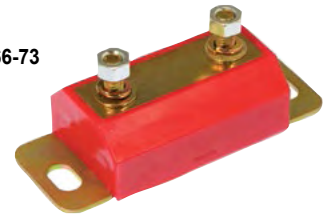

#6-1213 '83-'86 Capri McPherson Strut Tower Bushing Kit



#6-2005-BL Capri '79-'86 Total Kit  
with Transmission Mount

## Mazda

### BALL JOINT BOOTS

<b>(RX-7)</b>		
79-91	Ball Joint Boot Kit (2)	19-1713

### CONTROL ARM BUSHINGS, Front / Rear

<b>(RX-7)</b>		
86-91	Front Control Arm Bushing Kit, w/o Shells	12-203
86-91	Rear Control Arm Bushing Kit, w/o Shells	12-202
<b>(Miata)</b>		
90-97	Front Control Arm Bushing Kit w/o Shells	12-204
90-97	Rear Control Arm Bushing Kit w/o Shells	12-301

### DRIVETRAIN

<b>(Miata)</b>		
90-97	Rear Differential Bushing Kit	12-1601

### SWAY BAR BUSHINGS, Front / Rear

<b>(Protege, 323)</b>		
90-95	Front Sway Bar Bushing Kit, 3/4" Bar	12-1101
90-95	Rear Sway Bar Bushing Kit, 15/16" Bar	12-1102
<b>(RX-7)</b>		
86-91	Rear Sway Bar Bushing Kit, 14mm Bar	12-1103
86-91	Front Sway Bar Bushing Kit, 24mm Bar	19-1123
<b>(Mazda 3)</b>		
04-05	Rear Sway Bar Bushing Kit, 19mm Bar	12-1105
04-05	Front Sway Bar Bushing Kit, 21mm Bar	12-1104
<b>(Mazda 6)</b>		
04-05	Rear Sway Bar Bushing Kit, 18mm Bar	12-1107
04-05	Front Sway Bar Bushing Kit, 23mm Bar	12-1106
<b>(Miata)</b>		
90-97	Rear Sway Bar Bushing Kit, 1/2" Bar	12-1109
90-97	Front Sway Bar Bushing Kit, 19mm Bar	12-1108

### SWAY BAR END LINKS, Front

<b>(323, Protege)</b>		
79-82	End Link Bushing Kit	19-406
90-95	End Link Bushing Kit	4-401
<b>(RX-7)</b>		
79-85	End Link Bushing Kit	19-406
86-88	Front End Link Bushing Kit	12-401
86-88	Rear End Link Bushing Kit	12-402

### TIE ROD BOOTS

<b>(626, MX6)</b>		
88-92	Tie Rod Boot Kit (2)	19-1713
<b>(RX-7)</b>		
79-85	Tie Rod Boot Kit (2)	19-1713
86-91	Tie Rod Boot Kit (2)	19-1711

### TOTAL KITS

<b>(RX-7)</b>		
86-91	Total Kit	12-2001
<b>(Miata)</b>		
90-97	Total Kit	12-2002



#12-1108-BL Miata '90-'97 Front Sway Bar & End Link Bushing Kit



#12-204 Miata '90-'97 Front Control Arm Bushing Kit

## MG

### CONTROL ARM BUSHINGS, Front

<b>('60-63 MGA, '63-73 MGB "Rubber Nose", Midget)</b>		
60-73	Control Arm Bushing Kit, Lower, Inner	26-45046
62-74	Control Arm Bushing Kit, Lower, Inner (Midget)	26-45045
<b>(MGB, Midget)</b>		
63-73	Control Arm Bushing Kit, Upper Outer	26-45045
62-74	Control Arm Bushing Kit, Upper Outer (Midget)	26-45054

### DRIVE TRAIN

<b>(MGB)</b>		
74 1/2-80	Front Cross Member Mount Kit (U.S. Models)	26-49021
63-73	Gearbox Steady Rod Pad Kit	26-49018
63-73	Gearbox Steady Rod Eye Kit	26-49019
63-73	Gearbox X-Member Steady Kit	26-49020

### SHOCK MOUNTS

<b>('60-63 MGA, '63-73 MGB)</b>		
60-73	Rear Shock Link Kit	26-43038
63-73	Front Shock Link Kit (MGB)	26-43005

### SPRING & SHACKLE BUSHINGS

<b>(MGA, MGB)</b>		
60-63	Rear Spring Eye Kit, Front (MGA)	26-47076
60-73	Rear Spring Eye or Shackle Bushing Kit	26-47075
63-73	Rear Spring Eye Kit, Front (MGB)	26-47077
62-74	Rear Spring Eye Kit, Front (Midget)	26-47082
62-74	Rear Spring Eye or Shackle Bush. Kit (Midget)	26-47083

### SPRING PADS

<b>(MG- various)</b>		
60-73	Rear Spring Pad Kit	26-47078
<b>(MGA, MGB)</b>		
62-74	Rear Spring Pad Kit (Midget)	26-47084

### SWAY BAR MOUNTS, Front

<b>('63-73 MGB, '62-74 Midget)</b>		
62-74	Sway Bar Bushing Kit, 14mm Bar	26-42063

### SWAY BAR END LINKS, Front

62-74	End Link Kit (Midget)	26-42064
-------	-----------------------	----------



#26-47083 '62-'74 Rear Spring Eye or Shackle Bush. Kit (Midget)



#12-2002-BL Miata '90-'97 Total Kit

**Mitsubishi cars**

**CONTROL ARM BUSHINGS, Front**

<b>(3000GT)</b>		
94-99	Front Lower Control Arm Bushings NEW	4-227
<b>(Eclipse, Laser, Talon, AWD &amp; FWD)</b>		
90-94	Control Arm Bushing Kit, Lower	13-202
95-99	Control Arm Bushing Kit, Upper & Lower	13-201
<b>(Eclipse)</b>		
00-05	Control Arm Bushing Kit NEW	13-205
<b>(Lancer Evolution)</b>		
03-06	Control Arm Bushing Kit, Lower Inner	13-204

**CONTROL ARM BUSHINGS, Rear**

<b>(Eclipse, Talon, AWD &amp; FWD)</b>		
95-99	Control Arm Bushing Kit, Upper & Lower	13-301
<b>(Eclipse)</b>		
00-05	Control Arm Bushing Kit, Upper & Lower	13-302
<b>(Lancer Evolution)</b>		
03-06	Control Arm Bushing Kit, Upper	13-303
03-06	Control Arm Bushing Kit, Upper Inner	13-304

**DIFFERENTIAL BUSHINGS**

<b>(Lancer Evolution)</b>		
95-06	Rear Differential Bracket Mount Bushing Kit	13-1610

**MOTOR & TRANSMISSION MOUNT BUSHINGS & INSERTS**

<b>(3000GT)</b>		
91-99	Motor & Transmission Mount Kit	4-511
<b>(Eclipse, Laser, Talon FWD &amp; AWD Turbo &amp; Non-Turbo)</b>		
90-94	Trans. Mount Bushing Kit (Right, w/manual trans.)	13-501
90-94	Engine Mount Bushing Kit (Front, w/manual trans.)	13-505
90-94	Engine Mount Bushing Kit (Left, w/manual trans.)	13-503
90-94	Engine Mount Bushing Kit (Rear, w/manual trans.)	13-506
90-94	All 4 Locations Bushing Kit (w/manual trans.)	13-1902
<b>(Eclipse, Talon FWD &amp; AWD Turbo &amp; Non-Turbo)</b>		
95-99	Trans. Mount Bushing Kit (Right, w/manual trans.)	13-501
95-99	Engine Mount Insert Kit (Front)	13-502
95-99	Engine Mount Bushing Kit (Left)	13-503
95-99	Engine Mount Insert Kit (Rear)	13-504
95-99	All 4 Locations Bushing & Insert Kit	13-1901
<b>(Eclipse, 4 cyl.)</b>		
00-05	Engine Mount Bushing Kit (Right)	13-503
00-05	Engine Mount Bushing Kit (Front)	13-507
00-05	Trans. Mount Bushing Kit (Left)	13-509
00-05	Engine Mount Insert Kit (Rear)	13-510
00-05	All 4 Locations Bushing & Insert Kit	13-1904
<b>(Eclipse, V6)</b>		
00-05	Engine Mount Bushing Kit (Right)	13-503
00-05	Engine Mount Bushing Kit (Front)	13-507
00-05	Trans. Mount Bushing Kit (Left)	13-509
00-05	Engine Mount Bushing Kit (Rear)	13-508
00-05	All 4 Locations Bushing Kit	13-1903
<b>(Lancer Evolution)</b>		
08-13	Engine & Trans. Mount Bushings (Right & Left)	13-512

**SHIFTER BUSHINGS**

<b>(Eclipse, AWD &amp; FWD)</b>		
95-99	Shifter Bushing Kit AWD	13-1601
95-00	Shifter Bushing Kit FWD	13-1601
01-02	Shifter Bushing Kit FWD	13-1601
02-04	Shifter Bushing Kit AWD	13-1601

**SHOCK BUSHINGS**

<b>(Eclipse, Talon, AWD &amp; FWD)</b>		
95-99	Front Shock Bushing Kit	13-901
95-99	Rear Shock Bushing Kit	13-902

**STEERING RACK BUSHINGS**

<b>(Lancer Evolution)</b>		
03-06	Steering Rack Bushing Kit	13-701

**STRUT ARM BUSHINGS**

<b>(Lancer Evolution)</b>		
03-06	Front Trailing Arm Bushing Kit	13-1202

**SUB-FRAME MOUNTS**

<b>(Eclipse, Laser, Talon)</b>		
90-94	Sub-Frame Mount Kit (FWD)	13-101
90-94	Sub-Frame Mount Kit (AWD)	13-102

**SWAY BAR BUSHINGS, Front**

<b>(Eclipse, Laser, Talon)</b>		
90-94	Sway Bar Bushing Kit, 19mm Bar (FWD)	13-1104
90-94	Sway Bar Bushing Kit, 20mm Bar (AWD)	13-1105
95-99	Sway Bar Bush. Kit, 19mm Bar (FWD & AWD)	13-1101
<b>(Eclipse, Talon)</b>		
00-05	Sway Bar Bushing Kit, 16mm Bar	13-1106
<b>(Lancer Evolution)</b>		
03-06	Sway Bar Bushing Kit, 24mm Bar	13-1108

**SWAY BAR BUSHINGS, Rear**

<b>(Eclipse, Laser, Talon)</b>		
90-94	Sway Bar Bushing Kit, 20mm Bar (AWD)	13-1107
95-99	Sway Bar Bushing Kit, 15mm Bar (FWD)	13-1102
95-99	Sway Bar Bushing Kit, 18mm Bar (AWD)	13-1103
<b>(Eclipse)</b>		
00-05	Sway Bar Bushing Kit, 18mm Bar	19-1117
00-05	Sway Bar Bushing Kit, 19mm Bar	19-1118
<b>(Lancer Evolution)</b>		
03-06	Sway Bar Bushing Kit, 22mm Bar	13-1109

**TRACK ARM BUSHINGS**

<b>(Eclipse, Laser, Talon, FWD)</b>		
90-94	Rear Track Arm Bushing Kit	13-1201

**TIE ROD BOOTS**

<b>(Eclipse, Laser, Talon, FWD &amp; AWD)</b>		
90-94	Tie Rod Boot Kit (2)	19-1712

**TOTAL KITS**

<b>(Eclipse, Talon FWD &amp; AWD)</b>		
95-99	Total Kit	13-2001
<b>(Eclipse)</b>		
00-05	Total Kit	13-2002
<b>(Lancer Evolution)</b>		
03-06	Total Kit	13-2003

**Mitsubishi Truck**

**BODY MOUNTS**

83-90	Body Mount Kit, 20 Pcs. (Pickup 2WD)	4-104
85-89	Body Mount Kit (Montero 2DR)	13-103

**CONTROL ARM BUSHINGS**

83-90	Control Arm Bushing Kit, Lower (Pickup 2WD)	4-201
-------	---	-------

**SPRING & SHACKLE BUSHINGS, Rear**

83-90	Spring Eye and Shackle Bushing Kit (Pickup 2WD)	4-1006
-------	---	--------

**STRUT ARM BUSHINGS**

83-90	Strut Arm Bushing Kit (Pickup 2WD)	4-1201
-------	------------------------------------	--------

**SWAY BAR BUSHINGS**

83-90	Sway Bar Bushing Kit (Pickup 2WD)	4-1101
-------	-----------------------------------	--------

**TIE ROD BOOTS**

83-90	Tie Rod Boot Kit (2) (Pickup 2WD)	19-1712
-------	-----------------------------------	---------



**#13-2002-BL Eclipse '00-'05 Total Kit**

## Nissan/Datsun cars

### CONTROL ARM BUSHINGS, Front

<b>(240SX)</b>			
89-94	Control Arm Bushing Kit	14-207	
95-98	Control Arm Bushing Kit	14-208	
<b>(240, 260, 280Z)</b>			
70-78	Control Arm Bushing Kit	14-203	
<b>(280ZX)</b>			
79-83	Control Arm Bushing Kit, Lower Only	14-204	
<b>(300ZX)</b>			
84-89	Control Arm Bushing Kit, Lower Only	14-206	
<b>(510)</b>			
68-73	Control Arm Bushing Kit, Lower Only	14-205	
<b>(610)</b>			
73-76	Control Arm Bushing Kit, Lower Only	14-204	
<b>(350Z)</b>			
03-09	Control Arm & Radius Arm Bushing Kit	14-210	

### CONTROL ARM BUSHINGS, Rear

<b>(200SX)</b>			
00-03	Control Arm Bushing Kit	14-209	
<b>(240, 260, 280Z)</b>			
70-78	Control Arm Bushing Kit	14-301	
<b>(240SX)</b>			
89-94	Control Arm Bushing Kit	14-304	
89-94	Control Arm Bushing Kit, Lower Only	14-305	
95-98	Control Arm Bushing Kit	14-306	
<b>(280ZX)</b>			
79-83	Control Arm Bushing Kit	14-302	
<b>(300ZX)</b>			
84-89	Control Arm Bushing Kit, Lower	14-303	
<b>(350Z)</b>			
03-09	Control Arm, Radius Arm, Lower Link Bushing Kit	14-307	
<b>(510)</b>			
68-73	Control Arm Bushing Kit	14-302	
<b>(610)</b>			
73-76	Control Arm Bushing Kit	14-302	
<b>(810)</b>			
77-80	Control Arm Bushing Kit	14-302	

### DRIVE TRAIN

<b>(240, 260, 280Z)</b>			
70-78	Transmission X Member Kit	14-1601	
70-78	Differential Carrier "Mustache Bar" Mount Kit	14-1602	
<b>(350Z)</b>			
03-09	Differential Bushing Kit	14-1603	

### MOTOR MOUNT INSERTS

<b>(Sentra 1.6 &amp; 2.0 ltr., 200SX, NX2000, NX1600)</b>			
91-99	Engine Mount Insert Kit, Left or Rear	14-501	
91-99	Engine Mount Insert Kit, Right	14-502	
91-99	Engine Torque Strut Insert Kit	14-503	
91-99	All 4 Mount Kit	14-1901	
02-06	Motor Mount Inserts, Front (Sentra SE-R/Spec-V)	14-504	
02-06	Motor Mount Inserts, Rear (Sentra SE-R/Spec-V)	14-505	

### STEERING BUSHINGS

<b>(240SX)</b>			
89-98	Steering Rack Bushing Kit	14-704	
<b>(240, 260, 280Z)</b>			
70-78	Steering Coupler Kit	14-701	
<b>(240Z)</b>			
70-73	Rack & Pinion Bushing Kit (240Z)	14-702	
<b>(260, 280Z)</b>			
74-78	Rack & Pinion Bushing Kit (260Z, 280Z)	14-703	
<b>(350Z)</b>			
03-09	Rack & Pinion Bushing Kit	14-706	

### STRUT ROD BUSHINGS

<b>(240SX)</b>			
89-98	Strut Rod Bushing Kit	14-1205	
<b>(240, 260, 280Z, 280ZX)</b>			
70-83	Strut Rod Bushing Kit	14-1202	
<b>(300ZX)</b>			
84-7/87	Strut Rod Bushing Kit	14-1203	
8/87-89	Strut Rod Bushing Kit	14-1204	
90-96	Strut Rod Bushing Kit	14-1205	

### STRUT ROD BUMP STOPS

<b>(240, 260, 280Z)</b>			
70-78	McPheerson Strut Bump Stops Kit, Front or Rear	14-1301	

### SUBFRAME MOUNTS

<b>(240SX)</b>			
89-94	Rear Subframe Bushing Insert Kit	14-102	
<b>(300ZX)</b>			
84-89	Rear Subframe Bushing Kit	14-101	
<b>(350Z)</b>			
03-09	Subframe Bushing Kit	14-103	

### SWAY BAR BUSHINGS, Front

<b>(240, 260, 280Z)</b>			
70-78	Sway Bar Bushing Kit, 16mm Bar	14-1104	
70-78	Sway Bar Bushing Kit, 18mm Bar	14-1105	
70-78	Sway Bar Bushing Kit, 20mm Bar	14-1107	
<b>(280ZX, 300ZX)</b>			
79-89	Sway Bar Bushing Kit, 22mm Bar	14-1109	
79-89	Sway Bar Bushing Kit, 23mm Bar	14-1110	
84-89	Sway Bar Bushing Kit, 24mm Bar	14-1111	
<b>(240SX)</b>			
89-94	Sway Bar Bushing Kit, 24mm Bar	14-1117	
89-94	Sway Bar Bushing Kit, 25mm Bar	14-1118	
95-98	Sway Bar Bushing Kit, 27mm Bar	14-1119	
<b>(350Z)</b>			
03-04	Sway Bar Bushing Kit, 34mm Bar	14-1115	
03-09	Sway Bar Bushing Kit, 1 1/4" Bar	14-1124	



#14-2001 240Z  
'70-'73 Total Kit



#14-307-BL Nissan 350Z '03-'09  
Rear Control Arm, Radius Arm & Lower Link Bushing Set

*Continued...*

**SWAY BAR BUSHINGS, Rear**

<b>(240SX)</b>			
89-94	Sway Bar Bushing Kit, 15mm Bar	14-1120	
89-94	Sway Bar Bushing Kit, 17mm Bar	14-1121	
95-98	Sway Bar Bushing Kit, 16mm Bar	14-1122	
<b>(260, 280Z, 280ZX)</b>			
74-83	Sway Bar Bushing Kit, 20mm Bar	14-1108	
<b>(300ZX)</b>			
84-89	Sway Bar Bushing Kit, 22mm Bar	14-1112	
84-89	Sway Bar Bushing Kit, 23mm Bar	14-1113	
84-89	Sway Bar Bushing Kit, 26mm Bar	14-1114	
<b>(350Z)</b>			
03-09	Sway Bar Bushing Kit w/Brackets, 21mm Bar	14-1116	
03-09	Sway Bar Bushings Kit, 21mm Bar	14-1125	

**SWAY BAR END LINKS, Front / Rear**

<b>(240, 260, 280Z)</b>			
70-78	Front or Rear End Link Kit	19-405	
<b>(280ZX)</b>			
79-83	Front or Rear End Link Kit	19-401	
84-9/86	Front End Link Kit	19-401	
84-89	Rear End Link Kit	19-408	

**TIE ROD BOOTS**

<b>(240SX)</b>			
89-98	Tie Rod Boot Kit	19-1711	
<b>(240, 260, 280Z, 280ZX)</b>			
70-83	Tie Rod Boot Kit (2)	19-1711	
<b>(510, 610, 810)</b>			
70-86	Tie Rod Boot Kit (2)	19-1711	
<b>(300ZX)</b>			
84-89	Tie Rod Boot Kit (2)	19-1714	

**TOTAL KITS**

<b>(240Z)</b>			
70-73	Total Kit	14-2001	
<b>(260, 280Z)</b>			
74-78	Total Kit	14-2002	
<b>(280ZX)</b>			
79-83	Total Kit	14-2003	
<b>(240SX)</b>			
89-94	Total Kit	14-2005	
95-98	Total Kit	14-2006	
<b>(300ZX)</b>			
84-89	Total Kit	14-2004	
<b>(350Z)</b>			
03-09	Total Kit	14-2007	



#14-2003 '79-'83 280ZX Total Kit

**Nissan/Datsun Trucks**

**COIL SPRING LIFT SPACERS**

<b>(Nissan Titan 2 &amp; 4WD)</b>			
04-08	Front Coil Spring Lift Kit, 2" Lift	14-1701	

**CONTROL ARM BUSHINGS, Front**

<b>(720, Hardbody &amp; Pathfinder, 2WD &amp; 4WD)</b>			
80-86	Control Arm Bushing Kit	14-201	
86 1/2-97	Control Arm Bushing Kit	14-202	

**LEAF SPRING & SHACKLE BUSHINGS, Rear**

<b>(720, Hardbody 2WD)</b>			
80-86	Spring Eye and Shackle Bushing Kit	14-1001	
86 1/2-97	Spring Eye & Shackle Bushing Kit	14-1003	
<b>(720, Hardbody 4WD)</b>			
80-86	Spring Eye and Shackle Bushing Kit	14-1001	
86 1/2-97	Spring Eye and Shackle Bushing Kit	14-1002	

**STRUT ARM BUSHINGS, Front**

<b>(720, Hardbody &amp; Pathfinder, 2WD &amp; 4WD)</b>			
80-86	Strut Arm Bushing Kit	14-1201	

**SWAY BAR BUSHINGS, Front**

<b>(720, Hardbody &amp; Pathfinder, 2WD)</b>			
80-86	Sway Bar Bushing Kit, 21mm Bar	14-1101	
86 1/2-97	Sway Bar Bushing Kit, 23mm Bar	14-1102	
<b>(720, Hardbody &amp; Pathfinder, 4WD)</b>			
80-86	Sway Bar Bushing Kit, 21mm Bar	14-1103	
86 1/2-97	Sway Bar Bushing Kit, 20mm Bar	14-1106	
<b>(Titan 2WD &amp; 4WD)</b>			
04-06	Sway Bar Bushing Kit, 34mm Bar	14-1123	

**TIE ROD BOOTS**

<b>(720, Hardbody &amp; Pathfinder, 2WD &amp; 4WD)</b>			
82-97	Tie Rod Boot Kit (2)	19-1712	



#14-1701 Titan 2 & 4WD '04-08 Front Coil Spring Lift Kit, 2" Lift



#19-401 '79-'83 280ZX Front or Rear End Link Kit

## Oldsmobile

### BALL JOINT BOOTS

<b>(Cutlass)</b>		
64-72	Front Ball Joint Boot Kit (4)	19-1715
<b>(Cutlass, 442, F85, Europa RWD)</b>		
73-87	Ball Joint Boot Kit (4)	19-1717
<b>(Omega)</b>		
73-74	Ball Joint Boot Kit (4)	19-1715
75-79	Ball Joint Boot Kit (4)	19-1717
<b>(Full Size, Except Toronado &amp; FWD)</b>		
77-92	Ball Joint Boot Kit (4)	19-1717

### BODY MOUNTS

<b>(Cutlass, 442, F-85, Europa RWD)</b>		
78-88	Body Mount Kit	7-132

### COIL SPRING ISOLATORS, Rear

<b>(Full Size, except Toronado &amp; FWD)</b>		
66-84	Coil Spring Isolator Kit, Rear Upper	7-1706
<b>(Cutlass, 442, F-85, Europa RWD)</b>		
67-88	Coil Spring Isolator Kit, Rear Upper	7-1706
<b>(Toronado)</b>		
71-78	Coil Spring Isolator Kit, Rear Upper	7-1706

### CONTROL ARM BUSHINGS, Front

<b>(Full Size, except Toronado &amp; FWD)</b>		
71-73	Control Arm Bushing Kit, w/Shells	7-212
74-79	Control Arm Bushing Kit, w/Shells	7-214
80-92	Control Arm Bushing Kit, w/Shells	7-216
<b>(Cutlass, Calais, 442, F-85 RWD)</b>		
65	Control Arm Bushing Kit, w/Shells	7-221
66-72	Control Arm Bushing Kit, w/Shells (w/ oval lower)	7-222
66-72	Control Arm Bushing Kit, w/Shells (w/ round lower)	7-217
73	Control Arm Bushing Kit, w/Shells	7-212
74-77	Control Arm Bushing Kit, w/Shells	7-214
78-87	Control Arm Bushing Kit, w/Shells	7-223
<b>(Omega)</b>		
73-74	Control Arm Bushing Kit, w/Shells	7-217
75-79	Control Arm Bushing Kit, w/Shells	7-214
<b>(Achieva, Calais, Firenza FWD)</b>		
82-91	Control Arm Bushing Kit, w/Shells	7-224

### CONTROL ARM BUSHINGS, Rear

<b>(Cutlass, Calais, 442, F-85 RWD)</b>		
66-87	Control Arm Bushing Kit, w/Shells	7-225

### MOTOR MOUNTS

Various (See Application Charts on Pages 17-19)

### RADIATOR ISOLATORS

<b>(Cutlass, Calais, 442, F85)</b>		
68-72	Radiator Isolators, Small Block (4pcs)	7-1711
68-72	Radiator Isolators, Big Block (4pcs)	7-1712



#7-1711 '68-'72 Radiator Isolators, Small Block (4pcs)

### SWAY BAR BUSHINGS, Rear

<b>(Achieva, Calais FWD)</b>		
85-94	Sway Bar Bushing Kit, 15mm Bar	7-1156
85-94	Sway Bar Bushing Kit, 17mm Bar	7-1157
85-94	Sway Bar Bushing Kit, 19mm Bar	7-1158

### SWAY BAR END LINKS

<b>(Full Size, except Toronado &amp; FWD)</b>		
71-92	Front End Link Kit	19-408
<b>(Achieva, Calais) FWD</b>		
85-94	Front End Link Kit	19-408
<b>(Cutlass, Calais, Omega, 442, F-85 RWD)</b>		
64-77	Front End Link Kit	19-408
78-81	Front End Link Kit	19-412
73-79	Front End Link Kit (Omega)	19-408

### TIE ROD BOOTS

All	Tie Rod Boot Kit (2)	19-1712
-----	----------------------	---------

### TRANSMISSION MOUNTS

Various (See Application Chart on Page 17)

### TOTAL KITS

<b>(Cutlass, 442)</b>		
66-72	Total Kit (Includes Transmission Mount)	7-2001
74-77	Total Kit (Includes Transmission Mount)	7-2004
78-87	Total Kit (Includes Transmission Mount)	7-2007



#7-2007-BL Cutlass  
'78-'87 Total Kit



#7-2001 Cutlass  
'66-'72 Total Kit

## Pontiac / Firebird

### BALL JOINT BOOTS

67-69	Front Ball Joint Boot Kit (4) (Includes Trans Am)	19-1715
70-81	Ball Joint Boot Kit (4)	19-1717

### BODY MOUNTS

67-69	Body Mount Kit (Convertible Only) w/Hardware	7-120
67-75	Body Mount Kit (Hardtop) w/o Hardware	7-119
67-75	Body Mount Kit (Hardtop Only) w/Hardware	7-139
67-75	Body Mount Hardware Kit Only, (For 7-119)	7-140
76-81	Body Mount Kit w/Hardware	7-127

### BUMP STOPS

67-69	Front Lower Cont. Arm Bump Stops (2)	7-1301
-------	--------------------------------------	--------

### CONTROL ARM BUSHINGS, Front

67-69	Control Arm Bushing Kit w/Shells	7-217
70-72	Control Arm Bushing Kit w/Shells	7-218
73	Control Arm Bushing Kit w/Shells (w/ 1.625" OD lower)	7-212
74-79	Control Arm Bushing Kit w/Shells	7-214
80-81	Control Arm Bushing Kit w/Shells	7-219
82-92	Control Arm Bushing Kit w/Shells	7-220
93-02	Control Arm Bushing Kit	7-227

### CONTROL ARM BUSHINGS, Rear

82-02	Control Arm Bushing Kit w/Shells	7-226
-------	----------------------------------	-------

### DRIVETRAIN

84-92	Differential To Trans. Torque Arm Kit (See Diag.)	7-1611
84-92	Differential To Transmission Torque Arm Kit (84-92 Varies) (See Diagram Below)	7-1609
82-02	Panhard Rod Kit	7-1201
82-92	Secondary Trans. Crossmember Bushing Kit	7-1605

### MOTOR MOUNTS

Various (See Application Charts on Pages 14-19)

### SPRING & SHACKLE BUSHINGS, Rear

67-69	Spring Eye & Shackle Kit (Mono Leaf)	7-1010
67-69	Spring Eye & Shackle Kit (Multi Leaf)	7-1011
70-81	Spring Eye & Shackle Kit (Multi Leaf)	7-1012
67-69	Spring Eye & HD Shackle Kit (Mono Leaf)	7-1052
67-69	Heavy Duty Shackle Kit (Mono Leaf)	7-1053
67-81	Spring Eye & HD Shackle Kit (Multi Leaf)	7-1050
67-81	Heavy Duty Shackle Kit (Multi Leaf)	7-1051

### SPRING PADS, REAR

68-69	Spring Pad Kit, Upper Or Lower (Multi Leaf)	7-1701
70-81	Spring Pad Kit, Lower (Multi Leaf)	7-1702
70-81	Spring Pad Kit, Upper (Multi Leaf)	7-1703
68-69	Spring Pad Kit, Upper & Lower (Multi Leaf)	7-1708
70-81	Spring Pad Kit, Upper & Lower (Multi Leaf)	7-1709
67-69	Spring Pad Kit, Upper (Mono Leaf)	7-1704
67-69	Spring Pad Kit, Lower (Mono Leaf)	7-1705
67-69	Spring Pad Kit, Upper & Lower (Mono Leaf)	7-1707

### SWAY BAR BUSHINGS, Front

82-92	Sway Bar Bushing Kit, 30mm Bar	7-1133
82-92	Sway Bar Bushing Kit, 32mm Bar	7-1134
82-92	Sway Bar Bushing Kit, 34mm Bar	7-1135
93-02	Sway Bar Bushing Kit, 30mm Bar	7-1136
93-02	Sway Bar Bushing Kit, 32mm Bar	7-1137

### SWAY BAR BUSHINGS, Rear

67-81	Sway Bar Bushing Kit, 5/8" Bar	7-1122
67-81	Sway Bar Bushing Kit, 11/16" Bar	7-1123
67-81	Sway Bar Bushing Kit, 3/4" Bar	7-1124
67-81	Sway Bar Bushing Kit, 13/16" Bar	7-1125
67-81	Sway Bar Bushing Kit, 7/8" Bar	7-1126
67-81	Sway Bar Bushing Kit, 15/16" Bar	7-1127
67-81	Sway Bar Bushing Kit, 1" Bar (2 Bolt Clamp)	7-1128
67-81	Sway Bar Bushing Kit, 9/16" Bar	7-1116
67-81	Sway Bar Bushing Kit, 5/8" Bar	7-1117
67-81	Sway Bar Bushing Kit, 11/16" Bar	7-1118
67-81	Sway Bar Bushing Kit, 3/4" Bar	7-1119
67-81	Sway Bar Bushing Kit, 13/16" Bar	7-1120
67-81	Sway Bar Bushing Kit, 7/8" Bar	7-1121
82-02	Sway Bar Bushing Kit, 19mm Bar	7-1129
82-02	Sway Bar Bushing Kit, 21mm Bar	7-1130
82-02	Sway Bar Bushing Kit, 23mm Bar	7-1131
82-02	Sway Bar Bushing Kit, 24mm Bar (1 Bolt Clamp)	7-1132

### SWAY BAR END LINKS, Front

67-92	End Link Kit	19-406
93-02	End Link Kit	19-409

### TIE ROD BOOTS

67-02	Tie Rod Boot Kit (2)	19-1712
-------	----------------------	---------

### TRANSMISSION MOUNTS

Various (See Application Chart on Page 17)

### TOTAL KITS

(Firebird)		
67-69	Total Kit (Includes Transmission Mount)	7-2002
70-72	Total Kit (Includes Transmission Mount)	7-2028
73	Total Kit (Includes Transmission Mount)	7-2029
74-75	Total Kit (Includes Transmission Mount)	7-2005
76-79	Total Kit (Includes Transmission Mount)	7-2006
80-81	Total Kit (Includes Transmission Mount)	7-2031
82-92	Total Kit (Includes Transmission Mount)	7-2008
93-02	Total Kit (Includes Transmission Mount)	7-2009

## Pontiac Full size

### BALL JOINT BOOTS

64-81	Fl. Ball Joint Boot Kit (4)	19-1715
<b>(Bonneville-RWD, Grand Prix-to '81, Catalina)</b>		
73-86	Ball Joint Boot Kit (4)	19-1717

### BODY MOUNTS

<b>(Bonneville, Catalina, Grand Prix thru '81, Grandville, Safari Wagon) RWD</b>		
80-87	Body Mount Kit	7-132

### COIL SPRING ISOLATORS, Rear

<b>(Bonneville, Catalina, Grand Prix thru '81, Grandville, Safari Wagon) RWD</b>		
67-86	Coil Spring Isolator Kit, Rear Upper	7-1706

### CONTROL ARM BUSHINGS, Front

<b>(Bonneville-RWD, Grand Prix-to '81, Catalina)</b>		
71-73	Control Arm Bushing Kit, w/Shells	7-212
74-79	Control Arm Bushing Kit, w/Shells	7-214
80-81	Control Arm Bushing Kit, w/Shells	7-216
82-87	Control Arm Bushing Kit, w/Shells	7-223

### CONTROL ARM BUSHINGS, Rear

<b>(Bonneville-RWD, Catalina)</b>		
82-87	Control Arm Bushing Kit, w/Shells	7-225

### MOTOR MOUNTS

Various (See Application Charts on Pages 14-19)

### SWAY BAR END LINKS, Front

<b>(Bonneville-RWD, Grand Prix-to '81, Catalina)</b>		
71-88	End Link Kit	19-408

### TIE ROD BOOTS

All	Tie Rod Boot Kit (2)	19-1712
-----	----------------------	---------

### TRANSMISSION MOUNTS

Various(See Application Charts on Pages 17-19)



#7-2009 Firebird '93-'02 Total Kit

## Pontiac Mid Size & Compact

### BALL JOINT BOOTS

<b>(GTO, LeMans, Tempest, Grand Am)</b>		
64-72	Ball Joint Boot Kit (4)	19-1715
73-81	Ball Joint Boot Kit (4)	19-1717
<b>(Phoenix, Ventura)</b>		
71-74	Ball Joint Boot Kit (4)	19-1715
75-79	Ball Joint Boot Kit (4)	19-1717

### BODY MOUNTS

<b>(Grand Prix)</b>		
82-87	Body Mount Kit	7-132

### COIL SPRING ISOLATORS, Rear

<b>(GTO, Lemans, Tempest, Grand Am to '81, Grand Prix '82-87)</b>		
67-88	Coil Spring Isolator Kit, Rear Upper	7-1706

### CONTROL ARM BUSHINGS, Front

<b>(GTO, Le Mans, Tempest, Grand Am To '81, Grand Prix '82-88)</b>		
64-66	Control Arm Bushing Kit, w/Shells	7-221
67-72	Control Arm Bushing Kit, w/Shells (w/ oval lower)	7-222
73	Control Arm Bushing Kit, w/Shells	7-212
74-77	Control Arm Bushing Kit, w/Shells	7-214
78-81	Control Arm Bushing Kit, w/Shells	7-223
82-87	Control Arm Bushing Kit, w/Shells (Grand Prix)	7-223
04-06	Control Arm Bushing Kit, w/o Shells (GTO)	7-235
<b>(Phoenix, Ventura)</b>		
71-74	Control Arm Bushing Kit, w/Shells	7-217
75-79	Control Arm Bushing Kit, w/Shells	7-214
<b>(Grand Am &amp; Sunbird)</b>		
87-94	Control Arm Bushing Kit, w/Shells	7-224
<b>(Sunfire)</b>		
95-04	Control Arm Bushing Kit, w/o Shells	7-234

### CONTROL ARM BUSHINGS, Rear

<b>(GTO, Le Mans, Tempest, Grand Am To '81, Grand Prix '82-87)</b>		
64	Control Arm Bushing Kit (Uppers Must Reuse Existing Outer Shells)	7-314
65-81	Control Arm Bushing Kit, w/Shells	7-225
82-87	Control Arm Bushing Kit, w/Shells (Grand Prix)	7-225
04-06	Control Arm Bushing Kit (GTO)	7-317

### DRIVETRAIN

<b>(GTO)</b>		
04	Driveline Coupler NEW	7-1655

### MOTOR MOUNTS

Various (See Application Charts on Pages 14-19)		
<b>(Sunfire 5 spd. &amp; Auto Non Ecotec)</b>		
95-04	Upper Engine Mount Insert	7-513
95-04	Lower Engine Torque Strut	7-511

### RADIATOR ISOLATORS

<b>(GTO, LeMans, Tempest)</b>		
68-72	Radiator Isolators, Small Block (4pcs)	7-1711
68-72	Radiator Isolators, Big Block (4pcs)	7-1712

### STRUT ROD BUSHINGS

<b>(GTO)</b>		
04-06	Front Strut Rod Bushing Kit	7-1212



#7-2038-BL GTO, Le Mans '67-'72 Total Kit

### SWAY BAR BUSHINGS, Front

<b>(Grand Am, Sunbird, Sunfire)</b>		
87-98	Sway Bar Bushing Kit, 24mm Bar	7-1159
87-98	Sway Bar Bushing Kit, 26mm Bar	7-1160
87-98	Sway Bar Bushing Kit, 28mm Bar	7-1161
87-98	Sway Bar Bushing Kit, 30mm Bar	7-1162
<b>(GTO)</b>		
04-06	Sway Bar Bushing Kit, 28mm Bar*	7-1182

### SWAY BAR BUSHINGS, Rear

<b>(Grand Am, Sunbird)</b>		
87-94	Sway Bar Bushing Kit, 15mm Bar	7-1156
87-94	Sway Bar Bushing Kit, 17mm Bar	7-1157
87-94	Sway Bar Bushing Kit, 19mm Bar	7-1158
<b>(GTO)</b>		
04-06	Sway Bar Bushing Kit, 16mm Bar*	7-1183

\*Includes End Link Bushings

### SWAY BAR END LINKS, Front

<b>(GTO, Le Mans, Tempest, Grand Am To '81, Grand Prix '82-88)</b>		
64-72	End Link Kit	19-412
73-77	End Link Kit	19-408
78-81	End Link Kit	19-412
82-87	End Link Kit (Grand Prix)	19-408
<b>(Phoenix, Ventura)</b>		
71-74	Sway Bar End Link Kit	19-409
75-79	Sway Bar End Link Kit	19-408

### TIE ROD BOOTS

All	Tie Rod Boot Kit (2)	19-1712
-----	----------------------	---------

### TRANSMISSION MOUNTS

95-04	Transmission Mount Insert Kit (Front Mt. Manual Only)	7-514
95-04	Transmission Mount Insert Kit (Rear Mt. Manual Only)	7-515
Various	(See Application Chart on Page 12)	

### TOTAL KITS

1966	Total Kit (GTO, Le Mans, Incl. Trans. Mount)	7-2037
67-72	Total Kit (GTO, Le Mans, Incl. Trans. Mount)	7-2038
74-77	Total Kit (GTO, Le Mans, Incl. Trans. Mount)	7-2004
78-81	Total Kit (Grand Am, Incl. Trans. Mount)	7-2007
82-87	Total Kit (Grand Prix, Incl. Trans. Mount)	7-2007
04-06	Total Kit (GTO)	7-2041

## Pontiac Fiero

### CONTROL ARM BUSHINGS

84-88	Front Control Arm Bushing Kit, w/o Shells	7-207
84-87	Rear Control Arm Bushing Kit, w/o Shells	7-304

### MOTOR & DRIVE TRAIN

84-87	Engine Cradle Mount Kit	7-502
84-88	Engine Torque Strut Bushing Kit, 4 cyl.	7-501
85-86	Engine Torque Strut Bushing Kit, 6 cyl.	7-501

### TRAILING ARM BUSHINGS, Rear

88	Rear Link Trailing Arm Bushing Kit	7-305
----	------------------------------------	-------

### SWAY BAR BUSHINGS, Front

84-87	Sway Bar Bushing Kit, 23mm Bar	19-1122
-------	--------------------------------	---------

### SWAY BAR END LINKS, Front

84-87	End Link Kit	19-408
-------	--------------	--------

### TOTAL KITS

84-87	Total Kit	7-2034
-------	-----------	--------



#7-2041 GTO '04-'06 Total Kit



## Porsche TRANSMISSION

(356 All)		
50-85	Rear Linkage Coupler Bushing Kit	15-1601
(911, 912, & 930)		
65-88	Rear Linkage Coupler Bushing Kit	15-1601

## Rover DRIVE TRAIN

72-85	Front Panhard Rod Bushing Kit (Range Rover)	25-48034
-------	---	----------

## RADIUS ROD BUSHINGS

84-86	Radius Rod to Chassis Kit (Range Rover)	25-48101
52-78	Radius Rod to Differential Kit (110 Model)	25-48032
72-86	Radius Rod to Differential Kit (Range Rover)	25-48032
84-95	Radius Rod to Differential Kit (Range Rover)	25-48033

## SHOCK BUSHINGS

(110 Model)		
52-78	Front Shock Mount Bushing Kit, Lower	25-43022
52-78	Rear Shock Mount Bushing Kit, Lower	25-43022
(Land Rover, Series 1, 2, 2A, & 3)		
78-95	Front Shock Mount Bushing Kit, Upper	25-43022
78-95	Front Shock Mount Bushing Kit, Lower	25-43022
78-95	Rear Shock Mount Bushing Kit, Upper	25-43022
78-95	Rear Shock Mount Bushing Kit, Lower	25-43022
78-95	Rear Shock Mount Bushing Kit, Lower-109 Pin Type (Series 3)	25-43007
(Range Rover)		
84-95	Rear Shock Bushing Kit, Rear Upper (DeCarbon)	25-43022
84-95	Rear Shock Bushing Kit, Rear Lower (DeCarbon)	25-43001

## SPRING & SHACKLE BUSHINGS, Front / Rear

(Land Rover Series 1 & 2)		
52-57	Frt. Spring, Front Spring Eye & Shackle Kit (Ser. 1)	25-47072
52-57	RR Spring, Front Spring Eye & Shackle Kit (Ser. 1)	25-47072
58-61	Frt. Spring, Front Spring Eye & Shackle Kit (Ser. 2)	25-47072
58-61	RR Spring, Front Spring Eye & Shackle Kit (Ser. 2)	25-47072
(Land Rover Series 2A)		
61-78	Front Spring, Front Spring Eye Kit	25-47021
61-78	Front Spring, Rear Spring Eye Kit	25-47021
61-78	Rear Spring, Spring Eye & Shackle Kit	25-47021
(Land Rover Series 3)		
71-78	Front Spring, Front Spring Eye Kit	25-47021
71-78	Front Spring, Rear Spring Eye Kit	25-47021
71-78	Rear Spring, Spring Eye & Shackle Kit	25-47021

## STEERING DAMPER

84-95	Steering Damper Bushing Kit (Range Rover)	25-43010
-------	---	----------

## TRACK ROD

(Range Rover)		
84-95	Track Rod to Chassis Bushing Kit, 20mm	25-48040
84-95	Track Rod to Differential Bushing Kit	25-48036

## TRAILING ARM

(110 Model)		
52-78	Trailing Arm Eye Kit	25-48036
52-78	Trailing Arm Mount Kit, 20mm	25-48040
(Range Rover)		
86-95	Trailing Arm Kit, Upper (Range Rover)	25-48037

## SAAB CONTROL ARM BUSHINGS (SAAB 9-7X SUV)

05-09	Front Control Arm Bushing Kit	7-242
-------	-------------------------------	-------

## Saturn MOTOR MOUNTS

92-00	Engine Torque Strut Insert Kit	7-510
-------	--------------------------------	-------

## Scion CONTROL ARM BUSHINGS, Front (Scion tC)

13-16	Sway Bar Bushing Kit,	16-202
-------	-----------------------	--------

## CONTROL ARM BUSHINGS, Rear (Scion tC)

13-16	Sway Bar Bushing Kit,	16-305
-------	-----------------------	--------

## STEERING ARM BUSHINGS (Scion tC)

13-16	Rack and Pinion Kit	16-702
-------	---------------------	--------

## SWAY BAR BUSHINGS, Front (Scion tC)

05-06	Sway Bar Bushing Kit, 21mm Bar	18-1132
-------	--------------------------------	---------

## SWAY BAR BUSHINGS, Rear (Scion tC)

05-07	Sway Bar Bushing Kit, 18mm Bar	18-1117
-------	--------------------------------	---------

## SHIFTER BUSHINGS (FR-S)

13-14	Manual Shifter Bushing Kit (5 Spd.) NEW	16-1602
13-14	Manual Shifter Bushing Kit (6 Spd.) NEW	16-1603
13-14	Manual Shifter Rear Bushing (5 & 6 Spd.) NEW	16-1604



#18-1117-BL Scion tC '05-'07  
Rear Sway Bar Bushings

**TECH TIP:**  
A Shop Press is recommended when installing PROTHANE Bushings in Control Arms

## Subaru

### CONTROL ARM BUSHINGS

<b>(STI)</b>			
08-10	Front Control Arm Bushing Kit	16-304	
<b>(WRX)</b>			
02-06	Front Control Arm Bushing Kit	16-201	
08-10	Front Control Arm Bushing Kit	16-303	
08-10	Rear Lower Control Arm Bushing Kit	16-302	
<b>(BRZ)</b>			
13-16	Front Control Arm Bushing Kit	16-202	
13-16	Rear Control Arm Bushing Kit	16-305	

### DRIVE TRAIN

04-08	Rear Diff. Front Mount Bushing Kit ( <b>Legacy, Liberty</b> )	16-1609	
04-08	Rear Differential Insert Kit ( <b>Legacy, Liberty</b> )	16-1610	
08-09	Rear Differential Front Mount Bushing Kit ( <b>Forester</b> )	16-1609	
08-09	Rear Differential Insert Kit ( <b>Forester</b> )	16-1610	
08-11	Rear Differential Front Mount Bushing Kit ( <b>Impreza, STI, WRX</b> )	16-1609	
08-11	Rear Differential Insert Kit ( <b>Impreza, STI, WRX</b> )	16-1610	

### TRAILING ARM BUSHINGS, Rear

<b>(WRX)</b>			
02-06	Trailing Arm Bushing Kit	16-301	

### SHIFTER BUSHINGS

<b>(Forester, Impreza, Legacy, Outback, STI, WRX)</b>			
97-11	Rear Shifter Bushing ( <b>Impreza RS</b> )	16-1602	
98-06	5 Spd. Shifter Bushing Kit ( <b>WRX</b> )	16-1601	
00-11	Rear Shifter Bushing ( <b>Forester, Legacy</b> )	16-1602	
02-11	Rear Shifter Bushing ( <b>WRX</b> )	16-1602	
04-11	Rear Shifter Bushing ( <b>STI</b> )	16-1602	
<b>(BRZ)</b>			
13-14	5 Spd. Manual Shifter Bushing Kit	16-1602	
13-14	6 Spd. Manual Shifter Bushing Kit	16-1603	
13-14	Rear Manual Shifter Bushing (5 & 6 Spd.)	16-1604	

### STEERING BUSHINGS

04-08	Steering Rack Bushing Kit ( <b>Legacy, Liberty</b> )	16-701	
08-09	Steering Rack Bushing Kit ( <b>Forester</b> )	16-701	
08-11	Steering Rack Bushing Kit ( <b>Impreza, STI, WRX</b> )	16-701	
13-16	Steering Rack Bushing Kit ( <b>BRZ</b> )	16-702	



#16-1603 BRZ & FR-S  
'13-'14 6 Spd. Manual Shifter  
Bushing Kit



#16-140-BL STI & WRX '08-'10 Rear Subframe Insert Kit

### SUBFRAME

<b>(STI &amp; WRX)</b>			
08-10	Rear Subframe Insert Kit	16-140	

### SWAY BAR BUSHINGS, Front

<b>(WRX)</b>			
02-06	Sway Bar Bushing Kit, 20mm Bar	16-1101	

### SWAY BAR BUSHINGS, Rear

<b>(WRX)</b>			
02-06	Sway Bar Bushing Kit, 17mm Bar	16-1102	
04	Sway Bar Bushing Kit, 19mm Bar	16-1103	
05	Sway Bar Bushing Kit, 20mm Bar	16-1104	

### TOTAL KIT

02-06	Total Kit ( <b>WRX</b> )	16-2001	
04-09	Total Kit ( <b>Legacy, Outback</b> )	16-2004	
08-10	Total Kit ( <b>STI &amp; WRX</b> )	16-2003	
08-10	Total Kit ( <b>WRX</b> )	16-2002	
09-10	Total Kit ( <b>Forester</b> )	16-2005	



#16-2001 WRX '02-'06 Total Kit



#16-2005-BL '09-'10 (Forester) Total Kit

## Suzuki

### LEAF SPRING & SHACKLE BUSHINGS, Front / Rear

<b>(Samurai)</b>			
85-88 1/2	Front Spring Eye & Shackle Bushing Kit (O.E.M. Shackles)	17-1001	
85-88 1/2	Rear Spring Eye & Shackle Bushing Kit (O.E.M. Shackles)	17-1001	
85-88 1/2	Front Spring Eye & Shackle Bushing Kit (Aftermarket Shackles)	17-1002	
85-88 1/2	Rear Spring Eye & Shackle Bushing Kit (Aftermarket Shackles)	17-1002	

### SWAY BAR BUSHINGS, FRONT

<b>(Samurai)</b>			
85-88 1/2	Sway Bar & End Link Bushing Kit, 22mm Bar	17-1101	

### TIE ROD BOOTS

85-88 1/2	Tie Rod Boot Kit (2)	19-1711	
-----------	----------------------	---------	--

## Toyota car

### CONTROL ARM BUSHINGS, Front

<b>(Celica)</b>			
71-85	Control Arm Bushing Kit	18-210	
00-05	Control Arm Bushing Kit	18-203	
<b>(Celica Supra/Supra)</b>			
79-86-1/2	Control Arm Bushing Kit	18-210	
(Supra)			
94-96	Control Arm Bushing Kit	18-211	
<b>(Corolla GTS, SR-5) RWD</b>			
71-87	Control Arm Bushing Kit	18-210	
<b>(MR2)</b>			
85-89	Control Arm Bushing Kit	18-208	
91-95	Control Arm Bushing Kit, w/Strut Rod Bushings	18-209	
<b>(FRS)</b>			
13-16	Control Arm Bushing Kit -Front	16-202	

### CONTROL ARM BUSHINGS, Rear

<b>(Celica)</b>			
00-05	Control Arm Bushing Kit	18-302	
<b>(Corolla GTS, SR-5) RWD</b>			
85-87	Control Arm Bushing Kit	18-305	
<b>(MR2)</b>			
85-89	Control Arm Bushing Kit	18-208	
91-95	Control Arm Bushing Kit, w/Strut Rod Bushings	18-303	
<b>(FRS)</b>			
13-16	Control Arm Bushing Kit -Rear	16-305	

### SHIFTER BUSHINGS

<b>(FR-S)</b>			
13-14	5 Spd. Manual Shifter Bushing Kit	16-1602	
13-14	6 Spd. Manual Shifter Bushing Kit	16-1603	
13-14	Rear Manual Shifter Bushing (5 & 6 Spd.)	16-1604	

### STEERING BUSHINGS

<b>(Corolla GTS, SR-5) RWD</b>			
85-87	Steering Rack Bushing Kit (Manual Only)	18-702	
<b>(MR2)</b>			
85-89	Steering Rack Bushing Kit	18-702	
<b>(FR-S)</b>			
13-16	Rack & Pinion Bushing Kit	16-702	



#18-2007 Celica '00-'05 Total Kit

### STRUT ROD BUSHINGS, Front

<b>(Celica)</b>			
77-85	Strut Rod Bushing Kit	18-1203	
<b>(Celica Supra/Supra)</b>			
79-86 1/2	Strut Rod Bushing Kit	18-1203	
<b>(Corolla GTS, SR-5) RWD</b>			
75-87	Strut Rod Bushing Kit	18-1203	
<b>(MR2)</b>			
85-89	Strut Rod Bushing Kit	18-1203	

### STRUT ROD BUSHINGS, Rear

<b>(MR2)</b>			
85-89	Strut Rod Bushing Kit	18-1204	

### SWAY BAR BUSHINGS, Front

<b>(Celica)</b>			
00-05	Sway Bar Bushing Kit, 22mm Bar	19-1121	
<b>(Corolla GTS, SR-5) RWD</b>			
85-87	Sway Bar Bushing Kit, 21mm Bar (SR-5 Only)	19-1120	
85-87	Sway Bar Bushing Kit, 22mm Bar (GTS Only)	19-1121	
<b>(MR2)</b>			
85-89	Sway Bar Bushing Kit, 18mm Bar	18-1120	
91-95	Sway Bar Bushing Kit, 19mm Bar	18-1126	

### SWAY BAR BUSHINGS, Rear

<b>(Celica)</b>			
00-05	Sway Bar Bushing Kit, 17mm Bar	19-1116	
<b>(Corolla GTS, SR-5) RWD</b>			
85-87	Sway Bar Bushing Kit, 14mm Bar	18-1130	
85-87	Sway Bar Bushing Kit, 16mm Bar	18-1131	
<b>(MR2)</b>			
85-89	Sway Bar Bushing Kit, 18mm Bar	18-1120	
91-95	Sway Bar Bushing Kit, 19mm Bar	18-1127	

### SWAY BAR END LINKS, Front

70-86	End Link Kit ( <b>Corolla</b> )	19-403	
78-85	End Link Kit ( <b>Celica, GTS</b> )	19-403	
79-86	End Link Kit ( <b>Supra</b> )	19-403	
<b>(Corolla GTS, SR-5) RWD</b>			
85-87	Front End Link Kit	19-421	
85-87	Rear End Link Bushing Kit	18-401	

### TIE ROD BOOTS

70-86	Tie Rod Boot Kit (2) ( <b>Corolla</b> )	19-1712	
78-85	Tie Rod Boot Kit (2) ( <b>Celica, GTS</b> )	19-1712	
78-88	Tie Rod Boot Kit (2) ( <b>Cressida</b> )	19-1712	
79-86	Tie Rod Boot Kit (2) ( <b>Supra</b> )	19-1712	

### TRACK ARM BUSHINGS, Rear

<b>(Corolla GTS, SR-5) RWD</b>			
85-87	Track Arm Bushing Kit	18-1205	

### TOTAL KITS

<b>(Celica)</b>			
00-05	Total Kit	18-2007	
<b>(Corolla GTS, SR-5) RWD</b>			
85-87	Total Kit	18-2010	
<b>(MR2)</b>			
85-89	Total Kit	18-2008	
91-95	Total Kit	18-2009	
91-95	Total Kit, w/o Sway Bar Bushings	18-2012	



#18-2008-BL '85-'89 (MR2) Total Kit

## Toyota Truck

### BODY & CAB MOUNTS

<b>(Pickup, Tacoma 2WD)</b>		
95-00	Body Mount Kit	18-103
<b>(Pickup, Tacoma 4WD)</b>		
79-88	Body Mount Kit	18-101
89-00	Body Mount Kit	18-103
<b>(4Runner 4WD)</b>		
84-88	Body Mount Kit	18-102

### BUMP STOPS

<b>(Tacoma, 4Runner 2WD &amp; 4WD)</b>		
96-02	Front Bump Stops (4)	18-1301

### COIL SPRING LIFT SPACERS

<b>(Tacoma, 4Runner 2WD &amp; 4WD)</b>		
96-04	Front Coil Spring Lift Kit, 1.5" Lift (Includes: Bump Stops, 1.5" Coil Lift Spacers, Ft. Sway Bar Bushings: 25mm, 26mm, 27mm, '96-01 4Runner 26mm Ft. Sway Bar Bushings, '96-01 Tacoma Ft. End Link Bushings and Tie Rod Boots)	18-1701

### CONTROL ARM BUSHINGS, Front

<b>(Pickup, 2WD)</b>		
79-83	Control Arm Bushing Kit	18-201
84-88	Control Arm Bushing Kit	18-202
89-95	Control Arm Bushing Kit	18-205
<b>(Pickup, 4WD)</b>		
86-88	Control Arm Bushing Kit	18-204
89-95	Control Arm Bushing Kit	18-206
<b>(4Runner, 2WD &amp; 4WD)</b>		
86-88	Control Arm Bushing Kit	18-204
89-95	Control Arm Bushing Kit	18-206

### CONTROL ARM BUSHINGS, Rear

<b>(4Runner, 2WD &amp; 4WD)</b>		
90-95	Control Arm Bushing Kit	18-301

### LEAF SPRING & SHACKLE BUSHINGS, Front / Rear

<b>(Landcruiser FJ40 &amp; FJ60 4WD)</b>		
64-80	Front Spring Eye & Shackle Bushing Kit	18-1003
64-80	Rear Spring Eye & Shackle Bushing Kit	18-1003
81-87	Front Spring Eye & Shackle Bushing Kit	18-1007
81-87	Rear Spring Eye & Shackle Bushing Kit	18-1007
<b>(Pickup, 2WD)</b>		
79-83	Rear Spring Eye & Shackle Bushing Kit	18-1001
84-88	Rear Spring Eye & Shackle Bushing Kit	18-1002
89-95	Rear Spring Eye & Shackle Bushing Kit	18-1005

### LEAF SPRING & SHACKLE BUSHINGS, Front / Rear (Cont.)

<b>(Pickup, 4WD)</b>		
79-85	Front Spring Eye & Shackle Bushing Kit	18-1004
79-83	Rear Spring Eye & Shackle Bushing Kit	18-1001
84-88	Rear Spring Eye & Shackle Bushing Kit	18-1002
89-99	Rear Spring Eye & Shackle Bushing Kit	18-1006
79-85	Front Frame Shackle Bushing Kit	18-801
79-88	Rear Frame Shackle Bushing Kit	18-802
89-99	Rear Frame Shackle Bushing Kit	18-803
<b>(4Runner, 4WD)</b>		
84-85	Front Spring Eye and Shackle Bushing Kit	18-1004
84-88	Rear Spring Eye and Shackle Bushing Kit	18-1002
89	Rear Spring Eye and Shackle Bushing Kit	18-1006
<b>(4Runner, 4WD)</b>		
84-85	Front Frame Shackle Bushing Kit	18-801
84-88	Rear Frame Shackle Bushing Kit	18-802

### STEERING RACK BUSHINGS

<b>(Tacoma 4WD)</b>		
95-00	Steering Rack Bushing Kit	18-701
<b>(FRS)</b>		
13-16	Rack and Pinion Bushing Kit	16-702

### STRUT ARM BUSHINGS

<b>(Pickup, 2WD)</b>		
79-95	Strut Arm Bushing Kit	18-1201
<b>(Tacoma 2WD)</b>		
96-01	Strut Arm Bushing Kit	18-1202

### SWAY BAR BUSHINGS & END LINKS, Front

<b>(Pickup, 2WD)</b>		
79-88	Sway Bar Bushing & End Link Kit, 18mm Bar	18-1101
79-95	Sway Bar Bushing & End Link Kit, 25mm Bar	18-1102
89-95	Sway Bar Bushing & End Link Kit, 23mm Bar	18-1107
<b>(Pickup, 4WD)</b>		
79-88	Sway Bar Bushing & End Link Kit, 19mm Bar	18-1103
79-88	Sway Bar Bushing & End Link Kit, 23mm Bar	18-1104
89-95	Sway Bar Bushing & End Link Kit, 24mm Bar	18-1108
89-95	Sway Bar Bushing & End Link Kit, 27mm Bar	18-1111
<b>(Tacoma 2WD &amp; 4WD)</b>		
96-01	Sway Bar & End Link Bushing Kit, 25mm Bar	18-1112
96-01	Sway Bar & End Link Bushing Kit, 26mm Bar	18-1113
96-01	Sway Bar & End Link Bushing Kit, 27mm Bar	18-1114
<b>(Tundra 2WD &amp; 4WD)</b>		
00-01	Sway Bar & End Link Bushing Kit, 23mm Bar	18-1117
00-01	Sway Bar & End Link Bushing Kit, 24mm Bar	18-1118
<b>(4Runner 2WD &amp; 4WD)</b>		
84-88	Sway Bar Bushing & End Link Kit, 19mm Bar	18-1103
84-88	Sway Bar Bushing & End Link Kit, 23mm Bar	18-1104
89	Sway Bar Bushing & End Link Kit, 24mm Bar	18-1108
89	Sway Bar Bushing & End Link Kit, 27mm Bar	18-1111
90-95	Sway Bar & End Link Bushing Kit, 24mm Bar	18-1109
96-01	Sway Bar & End Link Bushing Kit, 26mm Bar	18-1115
<b>(Landcruiser)</b>		
60-89	Sway Bar & End Link Bushing Kit, 22mm Bar (FJ45/55)	18-1105
80-89	Sway Bar & End Link Bushing Kit, 23mm Bar (FJ60/62)	18-1106

### SWAY BAR BUSHINGS & END LINKS, Rear

<b>(4Runner 4WD)</b>		
90-95	Sway Bar & End Link Bushing Kit, 18mm Bar	18-1110
96-01	Sway Bar & End Link Bushing Kit, 19mm Bar	18-1116

### TORQUE ARM BUSHINGS, Front

<b>(Pickup 4WD, 4Runner 4WD)</b>		
79-85	Front Axle Torque Arm Bushing Kit	18-1501

### TIE ROD BOOTS

79-84	Tie Rod Boot Kit (2) (Pickup, 2WD & 4WD)	19-1712
84-95	Tie Rod Boot Kit (2) (4Runner 2WD & 4WD)	19-1712
60-89	Tie Rod Boot Kit (2) (Landcruiser, All)	19-1712

### TOTAL KITS

<b>(Pickup, Hilux &amp; Tacoma 2WD)</b>		
79-83	Total Kit	18-2001
84-88	Total Kit	18-2002
89-94	Total Kit	18-2004
<b>(Pickup, Hilux &amp; Tacoma 4WD)</b>		
79-85	Total Kit	18-2016
86-88	Total Kit	18-2003
89-94	Total Kit	18-2005
<b>(4Runner 4WD)</b>		
84-88	Total Kit (Fits Leaf & Control Arm Front Suspensions)	18-2006



#18-1701 '96-'04 Tacoma, 4Runner 2WD & 4WD 1.5" Front Coil Spring Lifts, Sway Bar Bushings, Bump Stops & Tie Rod Boot Kit



#18-2005-BL '89-'94 4WD Toyota Tacoma Pickup Total Kit

## Triumph

### CONTROL ARM BUSHINGS

<b>(Sprint)</b>			
74-81	Rear Control Arm Bushing Kit, Upper Front	27-46065	
74-81	Rear Control Arm Bushing Kit, Upper Rear	27-46066	
<b>(Stag 2000)</b>			
64-76	Rear Control Arm Bushing Kit,	27-46067	
<b>(TR5, TR6)</b>			
68-75	Front Control Arm Bushing Kit, Lower Inner	27-45096	
68-75	Front Control Arm Bushing Kit, Upper Inner	27-45095	
68-75	Rear Control Arm Bushing Kit	27-46067	

### EXHAUST MOUNTS

<b>(Stag 2000)</b>			
64-76	Exhaust Bracket Mount Kit	27-42060	

### RADIUS ROD BUSHINGS

64-80	Radius Rod Bushing Kit (Stag 2000)	27-48070	
74-80	Radius Rod Bushing Kit (Sprint)	27-43001	

### STEERING

<b>(Stag 2000)</b>			
64-76	Steering Column to Firewall Mount	27-41055	

### SWAY BAR MOUNTS, Front

<b>(Sprint)</b>			
74-80	Sway Bar Mounts	27-42920	

### SWAY BAR END LINKS, Front

<b>(Stag 2000)</b>			
64-76	End Link Kit	11-42915	



#27-46067-BL '64-'76 (Stag 2000) Rear Control Arm Bushing Kit



#22-202-BL '98-'06 New Beetle, Golf I, Jetta IV Front Control Arm Bushing Kit

## Volkswagen

### CONTROL ARM BUSHINGS, FRONT

<b>(Rabbit, Golf I, Jetta I)</b>			
75-84	Control Arm Bushing Kit		22-201
<b>(Golf II, Jetta II)</b>			
85-92	Control Arm Bushing Kit		22-202
<b>(Golf III, Jetta III)</b>			
93-98	Control Arm Bushing Kit		22-202
<b>(New Beetle, Golf IV, Jetta IV)</b>			
98-10	Control Arm Bushing Kit		22-202

### CONTROL ARM BUSHINGS, Rear

<b>(Rabbit, Golf I, Jetta I)</b>			
75-84	Control Arm Bushing Insert Kit		22-301
<b>(Golf II, Jetta II)</b>			
85-92	Control Arm Bushing Insert Kit		22-302
<b>(Golf III, Jetta III)</b>			
93-98	Control Arm Bushing Insert Kit		22-303

### MOTOR MOUNTS & INSERTS

<b>(Rabbit, Golf, GTI, Jetta, New Water-Cooled Beetle)</b>			
75-84	Front Motor Mount Kit		22-501
75-84	Rear Motor/Trans. Mount Kit		22-502
76-79	Left Motor Mount Insert Kit		22-504
80-84	Left Motor Mount Insert Kit		22-505
85-92	Rear Motor Mount Kit (Golf II, Jetta II)		22-503
98-06	Lower Engine Torque Arm Mount Kit (A4 Chassis)		22-506
98-10	Lower Motor Mount Insert (New Beetle)		22-507
99-10	Lower Motor Mount Insert (Golf & GTI)		22-507
99-08/12	Lower Motor Mount Insert (Jetta)		22-507

### SHOCK TOWER BUSHINGS

<b>(Rabbit, Golf I, Jetta I)</b>			
75-84	Rear Shock Tower Bushing Kit		22-901
<b>(Golf II, Jetta II)</b>			
85-92	Rear Shock Tower Bushing Kit		22-902
<b>(Golf III, Jetta III)</b>			
93-98	Rear Shock Tower Bushing Kit		22-902

### STEERING

<b>(Rabbit, Golf I, Jetta I)</b>			
79-84	Rack & Pinion Bushing Kit		22-701
<b>(Golf II, Jetta II)</b>			
85-92	Rack & Pinion Bushing Kit		22-702

### STRUT BUSHINGS

<b>(Rabbit, Golf I, II, III, Jetta I, II, III)</b>			
75-84	Strut Bushing Kit, Upper (Must Use 75-76 Upper Bearing Cap)		22-1201
75-98	Strut Adjustable Bump Stop Kit		22-1301

### SWAY BAR BUSHINGS, Front

<b>(Golf II &amp; III, Jetta II &amp; III)</b>			
85-98	Sway Bar & End Link Bushing Kit, 19mm Bar		22-1101
<b>(Golf IV, Jetta IV, New Water-Cooled Beetle)</b>			
98-06	Sway Bar & End Link Bushing Kit, 21mm Bar		22-1102

### TOTAL KITS

<b>(Rabbit, Golf I, Jetta I)</b>			
75-84	Total Kit		22-2008
<b>(Golf II, Golf III, Jetta II, Jetta III)</b>			
85-98	Total Kit		22-2009

**NOTE: WATER COOLED VOLKSWAGENS:** • A1 Chassis = Rabbit, Scirocco I & II, Jetta I • A2 Chassis = Golf II, Jetta II, Corrado • A3 Chassis = Golf III, Jetta III, Cabrio  
 • A4 Chassis = Golf IV, Jetta IV, New Beetle • Cabriolet = All convertibles, also called Rabbit • Golf 1985-92 = Known as Golf II  
 • Golf 1993-98 = Known as Golf III  
 • Golf 1999-05 = Known as Golf IV • Jetta 1980-84 = Known as Jetta I  
 • Jetta 1985-92 = Known as Jetta II • Jetta 1993-98 = Known as Jetta III  
 • Jetta 1999-05 = Known as Jetta IV • Rabbit 1975-84 = Known as Golf I outside USA • Scirocco 1975-81 = Known as Scirocco I • Scirocco 1982-88 = Known as Scirocco II



#22-2009 '85-'98 (Golf II, Golf III, Jetta II, Jetta III) Total Kit

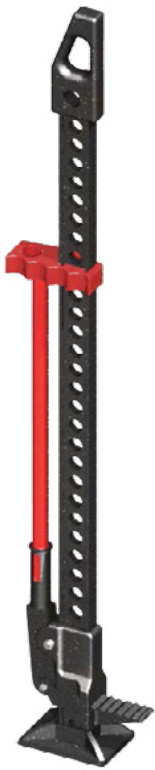

### JACK GRABBER™

Fits Hi-Lift™ Jacks - Eliminates rattle noise

19-1404



### URETHANE LIFT PADS™

Fits 2-post Hydraulic Vehicle Lifts on Forward™, Eagle™, Gemini™, and American™ lifts. Set of four.

Has two 3.75" center line mounting holes. Uses existing lift hardware. 19-1451



### URETHANE HYDRAULIC FLOOR JACK PADS™

Fits up to 3" diameter Floor Jacks  
 Fits up to 5" diameter Floor Jacks  
 Fits up to 7 1/4" diameter Floor Jacks  
 Fits up to 9" diameter Floor Jacks  
 Fits up to 3" diameter Floor Jacks

19-1403  
 19-1405  
 19-1401  
 19-1402  
 19-1403



### URETHANE JACK STANDS PADS™

Fits Jack Stands with 1 1/4" x 4" Heads  
 Fits Jack Stands with 1 1/2" x 6" Heads

19-1412  
 19-1413

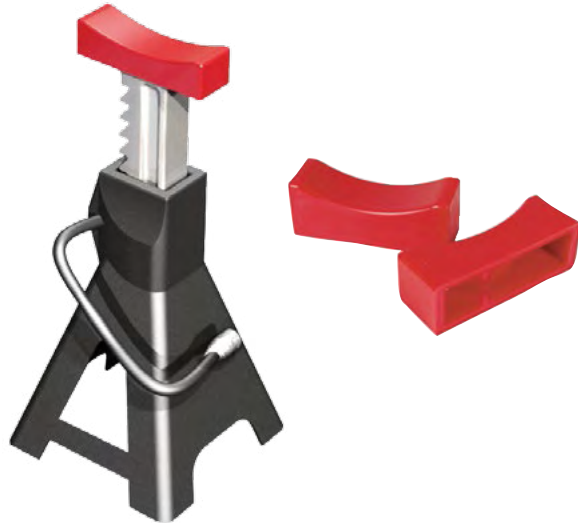

### URETHANE VISE PADS™

Universal Soft Jaws with magnetic inserts affixes to any vise

19-1450

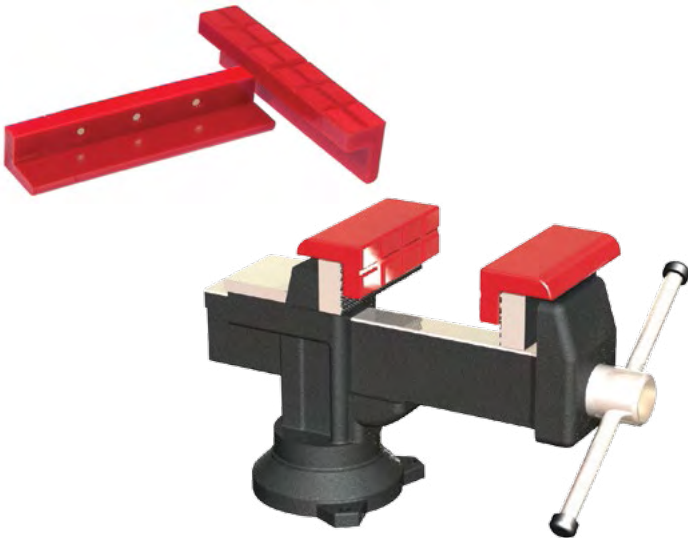

\* Due to the many sizes and styles of jacks and jack stands available, select the size that best fits your application.

### Disclaimer

Disclaimer: The use of recognized automobile manufacturers (i.e. Chevrolet, Ford, Chrysler, Honda, Toyota & Volkswagen) and their respective model names/numbers (i.e. Chevelle, Corvette, Cobalt, Dodge Ram, Ford F-150/F-250, Scion & VW Golf) for DEE ENGINEERING, Inc. is for the sole purpose of application and description and in no way denotes their use to intend a direct connection between DEE ENGINEERING, Inc. or PROTHANE™ Products and those automobile manufacturers or factories.

## Prothane Promotional Items

We offer all types of promotional supplies from Banners to Hats and diverse selection of T-Shirts and Sweaters. For sizes and merchandise information, please see the PROTHANE™ Price Sheet.

## Limited Edition T-Shirts

Quality cotton T's available in white and black with distinctive graphics on the back and PROTHANE™ logo over the front breast.



### T-Shirts

Black L	Z9510-26
Black XL	Z9510-27
Black XXL	Z9510-28
White L	Z9510-12
White XL	Z9510-13
White XXL	Z9510-14

### Sweatshirts

Gray L	Z9503-11
Gray XL	Z9503-12
Gray XXL	Z9503-13

### Polo Shirts - Embroidered

Black L	Z9515-12
Black XL	Z9515-13
Black XXL	Z9515-14

## CAPS

Quality cotton black with red accents and PROTHANE™ logo. Adjustable

### Cap - Embroidered

Black	Z9520-20
-------	----------

## PROMOTIONAL

Car Decal 6x26" white	Z9533-15
Authorized Dealer Decal	Z9535
Diecut Decal 3x22" white	Z9539-15
Wall Poster 12x30"	Z9553
Banner 24x60" white	Z9553-11

## Where to buy PROTHANE products



© PROTHANE 2019 - All rights reserved

**PROTHANE products are sold through authorized PROTHANE DEALERS. Products may be purchased at retail outlets or on-line. Check with your local dealer to see if they carry PROTHANE. Or go to the PROTHANE website. Then click on the "WHERE TO BUY" icon and select a dealer from the list. Please note we are continually updating our list. All PROTHANE kits and components are boxed and ready for shipment.**

[www.prothane.com](http://www.prothane.com)



# HIGH PERFORMANCE URETHANE



## SUSPENSION • CHASSIS BUSHINGS • MOUNTS

AXLE PIVOT BUSHINGS • BALL JOINT & TIE ROD BOOTS • BODY MOUNTS •  
BUMP STOPS • COIL LIFT ISOLATORS • COIL SPRING ISOLATORS • CONTROL  
ARM BUSHINGS • LEAF SPRING BUSHINGS • MOTOR MOUNTS • SWAY BAR  
BUSHINGS • TOTAL KITS • TRACK ARM BUSHINGS • TRANSMISSION MOUNTS  
• AND MORE

DISTRIBUTED BY:

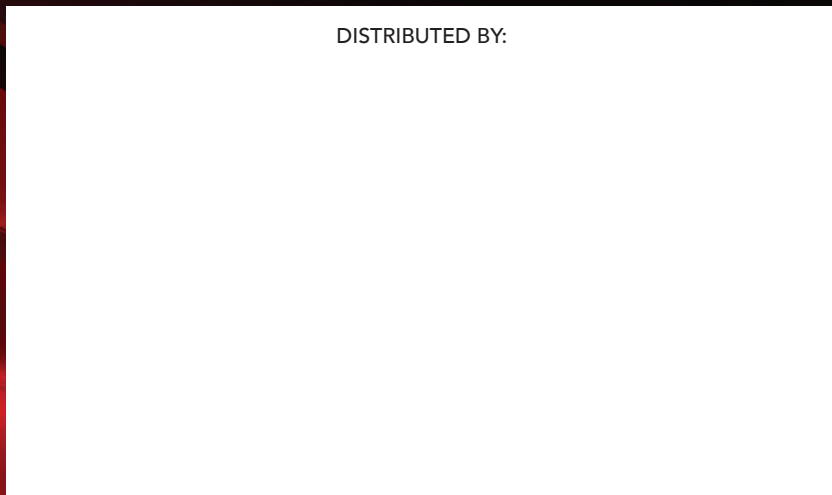

[www.PROTHANE.com](http://www.PROTHANE.com)

Toll Free Tech- 888-776-8426

3100 Airway Ave., #106, Costa Mesa, CA 92626

PROTHANE IS A DIVISION OF DEE ENGINEERING

## FOR ALL CARS AND TRUCKS

